

BRABURA

OUTDOOR KITCHENS

BRABURA
OUTDOOR KITCHENS

**Stainless Steel
Outdoor Kitchens**

Cocinas de Exterior
en Acero Inoxidable



BRABURA
GRILLS

Brabura Outdoor Kitchens	04
Modula Outdoor Kitchens Cocinas de Exterior Modula	10
LITE Series Kitchens Cocinas LITE Series	48
Grills Barbacoas	54
Kalentia & Gelantia	66
Accessories Accesorios	88
Technical data Datos Técnicos	108
Warranty Garantía	134

Love the Outdoors

At Brabura Grills, our purpose is to bring people together through the joy of outdoor cooking, where every meal turns into an unforgettable memory. We offer our expertise to create a welcoming environment where family and friends gather, share stories, and savor life. Discover the art of sharing unique moments with Brabura Grills.

"Together, we craft exciting moments"

En Brabura Grills nuestro propósito es unir a las personas a través de la alegría de cocinar al aire libre, donde cada comida se convierte en un recuerdo imborrable. Te brindamos nuestra experiencia para crear un ambiente cálido donde familiares y amigos se reúnen, comparten historias y disfrutan de la vida. Descubre el arte de compartir momentos únicos con Brabura Grills.

"Juntos forjamos instantes emocionantes"



Family Tradition of more than 45 years

Tradición Familiar de más de 45 años

At Brabura, we are more than just a company; we are a community bound by passion and a vision to revolutionize the outdoor culinary experience. Our story begins in the heart of tradition, surrounded by master craftsmen and a heritage of over 45 years in crafting grills and griddles for the European market. A group of friends dared to dream big and gave life to Brabura.

What sets us apart is not only the quality of our products but the unwavering determination that has driven us to explore the world in pursuit of culinary excellence. Every experience enriches our vision and becomes a fundamental ingredient in Brabura's recipe. The Mediterranean culture, with its love for great food and outdoor living, is woven into the very fabric of our company.

En Brabura, somos más que una empresa, somos una comunidad unida por la pasión y la visión de transformar la experiencia culinaria al aire libre. Nuestra historia comienza en el corazón de la tradición, donde rodeados de maestros artesanos y la herencia de más de 45 años en la fabricación de grills y planchas para el mercado europeo, un grupo de amigos decidimos soñar en grande y dar vida a Brabura.

Lo que nos distingue no es solo la calidad de nuestros productos, sino la inquebrantable determinación que nos ha llevado a explorar el mundo en busca de la excelencia culinaria. Cada experiencia enriquece nuestra visión y se convierte en un ingrediente fundamental en la receta de Brabura. La cultura mediterránea, con su pasión por la buena comida y la vida al aire libre, está tejida en cada fibra de nuestra empresa.

With over two decades dedicated to designing and manufacturing outdoor cooking appliances for the European market, we have built a solid reputation. Our commitment to innovation and quality is unparalleled. We are a company that values closeness and customer satisfaction, where our entrepreneurial spirit melds with experience and dedication to deliver cutting-edge solutions and high-quality products.

At Brabura, each day presents an opportunity to make outdoor cooking exciting and delightful. We are deeply passionate about what we do, and this passion is reflected in all our products and the service we provide. We are here to ensure that you and your family enjoy special moments outdoors, with the certainty that Brabura stands by your side, ready to meet your culinary needs.

We invite you to join us on this exhilarating journey. Discover the Brabura difference and transform your outdoor kitchen into an authentic culinary paradise.

Con más de dos décadas dedicadas al diseño y fabricación de aparatos de cocina al aire libre para el mercado europeo, hemos forjado una sólida reputación. Nuestro compromiso con la innovación y la calidad es insuperable. Somos una empresa que valora la cercanía y la satisfacción del cliente, y nuestro espíritu emprendedor se fusiona con la experiencia y la dedicación para ofrecer soluciones vanguardistas y productos de alta calidad.

En Brabura, cada día es una oportunidad para hacer que cocinar al aire libre sea emocionante y delicioso. Nos apasiona lo que hacemos, y eso se refleja en todos nuestros productos y en el servicio que brindamos. Estamos aquí para que tú y tu familia disfruten de momentos especiales al aire libre, con la certeza de que Brabura está a tu lado, listo para satisfacer tus necesidades culinarias.

Te invitamos a unirte a nosotros en este emocionante viaje. Descubre la diferencia Brabura y transforma tu cocina al aire libre en un auténtico paraíso culinario.



Embark on a culinary journey with Brabura!

¡Sumérgete en un emocionante universo culinario con Brabura!

Where every product, from our grills and griddles to our outdoor kitchens, is meticulously designed to elevate your outdoor cooking experience.

Gather your family and friends, ignite your creativity, and craft delicious creations in your garden oasis.

Whether it's an irresistibly delectable Mediterranean breakfast, an exquisite rib-eye steak, or a perfectly crafted burger, our products empower you to unleash the chef within while relishing an exceptional ambiance in your outdoor space.

Brabura offers you a world of culinary possibilities!

Cada uno de nuestros productos, desde las barbacoas y planchas hasta las cocinas al aire libre, está diseñado para llevar tu experiencia gastronómica en exteriores a nuevas alturas.

Invita a tus familiares y amigos, enciende la chispa de tu creatividad y despierta el chef que llevas dentro mientras preparas exquisitas delicias en tu propio oasis al aire libre.

Ya sea un tentador desayuno mediterráneo, un succulento costillar o la hamburguesa perfecta, nuestros productos te dan el poder de explorar tus habilidades culinarias y disfrutar de un entorno excepcional en tu espacio exterior.

¡Brabura te ofrece una experiencia culinaria sin límites!



Modula Outdoor Kitchens

Cocinas de Exterior
Modula



Modula Outdoor Kitchen

At Brabura, we offer you intelligent solutions for outdoor kitchens. When you combine these modules with our innovative cooking appliances, the result is an unparalleled outdoor culinary experience.

The choice is in your hands!



Explore the versatility of our outdoor kitchen modules, where you take the reins of design to create a unique space that fully adapts to your needs and budget.

Crafted with high-quality materials that stand the test of time. From durable stainless steel with double powder coating, certified by Qualisteelcoat, to robust bamboo wood capable of withstanding the most demanding environments. These materials not only ensure durability but also add style to your outdoor space

Our kitchen modules are specifically designed to seamlessly fit with our entire range of cooking appliances, such as barbecues and griddles.

They also include surprising features like a tray for gas cylinder extraction spacious storage drawers, and hinges with guides that ensure a perfect fit for doors and drawers.

But what truly makes our kitchens unique is our innovative Neolith countertop. Available in two elegant finishes: Iron Frost and Iron Satin, in black and white, respectively. These porcelain materials are exceptionally resistant to the elements, thanks to their non-porous surface, which can also withstand scratches and high temperatures.

Explora la versatilidad de nuestros módulos de cocina al aire libre, donde tú tomas las riendas del diseño para crear un espacio único que se adapte por completo a tus necesidades y presupuesto.

Fabricadas con materiales de alta calidad que resisten el paso del tiempo. Desde el duradero Acero inoxidable de doble recubrimiento en polvo certificado por Qualisteelcoat hasta la robusta madera de bambú, capaz de soportar los entornos más exigentes. Estos materiales no solo aseguran durabilidad, sino que también aportan estilo a tu espacio al aire libre.

Nuestros módulos de cocina están especialmente diseñados para encajar perfectamente con toda nuestra gama de aparatos de cocción, como barbacoas y planchas.

Cocinas de Exterior Modula

En Brabura, te brindamos soluciones inteligentes para cocinas al aire libre. Cuando combinas estos módulos con nuestros innovadores aparatos de cocción, el resultado es una experiencia culinaria al aire libre sin igual.

La elección está en tus manos!

Además, incorporan características sorprendentes, como la bandeja para extraer la bombona de gas, amplios cajones de almacenamiento y guías con bisagras que garantizan un ajuste perfecto de puertas y cajones

Pero lo que hace que nuestras cocinas sean realmente únicas es nuestra innovadora encimera Neolith. Disponible en ocho elegantes acabados. Estos materiales porcelánicos son excepcionalmente resistentes a las inclemencias del tiempo, gracias a su superficie no porosa, que también puede soportar arañazos y altas temperaturas.

Cooking Cocinado



KC 80 Grill

Ref BKC0034



SPECIFICATIONS · CARACTERÍSTICAS

Module Measurements Medidas del Módulo	W 78.4 x D 70 x H 92 cm
Countertop Material Material de la Encimera	Neolith sintered stone Piedra sinterizada Neolith
Body Material Material	Ultra durable powder coated stainless steel (Qualisteelcoat) Acero inoxidable con recubrimiento en polvo ultra duradero (Qualisteelcoat)
Number of Doors Número de Puertas	2
Magnetic Close Door Puerta con Cierre Magnético	✓
Soft Close Hinge Bisagras con cierre suave	✓
Gas Bottle Support Soporte Bombona de Gas	✓
Accessible Leveling Feet Pies Niveladores Accesibles	✓
Grill & End Panels not included Barbacoa y End Panels no incluidos	



Customise Top Finish · Personaliza la Encimera

 Nero Zimbawe	 Basalt Black
 Pietra Di Luna	 Iron Corten
 Iron Frost	 Pietra Di Osso
 Summer Dala	 Barro

Set Cabinet Colour · Define el Color del Módulo

 Anthracite Grey Gris Antracita	 Pearl White Blanco Perla
--	--

Select Handle · Selecciona el Tirador

 Wood Bambú	 Matte Black Negro Mate	 Silver Metálico
--	--	---

KC 100 Grill

Ref BKC0006



SPECIFICATIONS · CARACTERÍSTICAS

Module Measurements Medidas del Módulo	W 100 x D 70 x H 92 cm
Countertop Material Material de la Encimera	Neolith sintered stone Piedra sinterizada Neolith
Body Material Material	Ultra durable powder coated stainless steel (Qualisteelcoat) Acero inoxidable con recubrimiento en polvo ultra duradero (Qualisteelcoat)
Number of Doors Número de Puertas	2
Magnetic Close Door Puerta con Cierre Magnético	✓
Soft Close Hinge Bisagras con cierre suave	✓
Accessible Leveling Feet Pies Niveladores Accesibles	✓
Grill & End Panels not included Barbacoa y End Panels no incluidos	

Customise Top Finish · Personaliza la Encimera

Nero Zimbawe	Basalt Black
Pietra Di Luna	Iron Corten
Iron Frost	Pietra Di Osso
Summer Dala	Barro

Set Cabinet Colour · Define el Color del Módulo

Anthracite Grey Gris Antracita	Pearl White Blanco Perla
-----------------------------------	-----------------------------

Select Handle · Selecciona el Tirador

Wood Bambú	Matte Black Negro Mate	Silver Metálico
---------------	---------------------------	--------------------



KC 120 Grill

Ref BKC0005



SPECIFICATIONS · CARACTERÍSTICAS

Module Measurements Medidas del Módulo	W 118.4 x D 70 x H 92 cm
Countertop Material Material de la Encimera	Neolith sintered stone Piedra sinterizada Neolith
Body Material Material	Ultra durable powder coated stainless steel (Qualisteelcoat) Acero inoxidable con recubrimiento en polvo ultra duradero (Qualisteelcoat)
Number of Doors Número de Puertas	2
Magnetic Close Door Puerta con Cierre Magnético	✓
Soft Close Hinge Bisagras con cierre suave	✓
Gas Bottle Support Soporte Bombona de Gas	✓
Accessible Leveling Feet Pies Niveladores Accesibles	✓
Grill & End Panels not included Barbacoa y End Panels no incluidos	

Customise Top Finish · Personaliza la Encimera

Nero Zimbawe	Basalt Black
Pietra Di Luna	Iron Corten
Iron Frost	Pietra Di Osso
Summer Dala	Barro

Set Cabinet Colour · Define el Color del Módulo

Anthracite Grey Gris Antracita	Pearl White Blanco Perla
-----------------------------------	-----------------------------

Select Handle · Selecciona el Tirador

Wood Bambú	Matte Black Negro Mate	Silver Metálico
---------------	---------------------------	--------------------



KC 120 Drop-In Grill

Ref BKC0028



SPECIFICATIONS · CARACTERÍSTICAS

Module Measurements Medidas del Módulo	W 118.4 x D 70 x H 92 cm
Countertop Material Material de la Encimera	Neolith sintered stone Piedra sinterizada Neolith
Body Material Material	Ultra durable powder coated stainless steel (Qualisteelcoat) Acero inoxidable con recubrimiento en polvo ultra duradero (Qualisteelcoat)
Number of Doors Número de Puertas	2
Magnetic Close Door Puerta con Cierre Magnético	✓
Soft Close Hinge Bisagras con cierre suave	✓
Gas Bottle Support Soporte Bombona de Gas	✓
Accessible Leveling Feet Pies Niveladores Accesibles	✓
Grill & End Panels not included Barbacoa y End Panels no incluidos	

Customise Top Finish · Personaliza la Encimera

Nero Zimbawe	Basalt Black
Pietra Di Luna	Iron Corten
Iron Frost	Pietra Di Osso
Summer Dala	Barro

Set Cabinet Colour · Define el Color del Módulo

Anthracite Grey Gris Antracita	Pearl White Blanco Perla
-----------------------------------	-----------------------------

Select Handle · Selecciona el Tirador

Wood Bambú	Matte Black Negro Mate	Silver Metálico
---------------	---------------------------	--------------------



KC 80 Plancha

Ref BKC0007



SPECIFICATIONS · CARACTERÍSTICAS

Module Measurements Medidas del Módulo	W 78.4 x D 70 x H 92 cm
Countertop Material Material de la Encimera	Neolith sintered stone Piedra sinterizada Neolith
Body Material Material	Ultra durable powder coated stainless steel (Qualisteelcoat) Acero inoxidable con recubrimiento en polvo ultra duradero (Qualisteelcoat)
Number of Doors Número de Puertas	2
Magnetic Close Door Puerta con Cierre Magnético	✓
Soft Close Hinge Bisagras con cierre suave	✓
Gas Bottle Support Soporte Bombona de Gas	✓
Accessible Leveling Feet Pies Niveladores Accesibles	✓
Plancha & End Panels not included Plancha y End Panels no incluidos	

Customise Top Finish · Personaliza la Encimera

Nero Zimbawe	Basalt Black
Pietra Di Luna	Iron Corten
Iron Frost	Pietra Di Osso
Summer Dala	Barro

Set Cabinet Colour · Define el Color del Módulo

Anthracite Grey Gris Antracita	Pearl White Blanco Perla
-----------------------------------	-----------------------------

Select Handle · Selecciona el Tirador

Wood Bambú	Matte Black Negro Mate	Silver Metálico
---------------	---------------------------	--------------------



KC 100 Plancha

Ref BKC0023



SPECIFICATIONS · CARACTERÍSTICAS

Module Measurements Medidas del Módulo	W 100 x D 70 x H 92 cm
Countertop Material Material de la Encimera	Neolith sintered stone Piedra sinterizada Neolith
Body Material Material	Ultra durable powder coated stainless steel (Qualisteelcoat) Acero inoxidable con recubrimiento en polvo ultra duradero (Qualisteelcoat)
Number of Doors Número de Puertas	2
Magnetic Close Door Puerta con Cierre Magnético	✓
Soft Close Hinge Bisagras con cierre suave	✓
Gas Bottle Support Soporte Bombona de Gas	✓
Accessible Leveling Feet Pies Niveladores Accesibles	✓

Plancha & End Panels not included
Plancha y End Panels no incluidos

Customise Top Finish · Personaliza la Encimera

Nero Zimbabwe	Basalt Black
Pietra Di Luna	Iron Corten
Iron Frost	Pietra Di Osso
Summer Dala	Barro

Set Cabinet Colour · Define el Color del Módulo

Anthracite Grey Gris Antracita	Pearl White Blanco Perla
-----------------------------------	-----------------------------

Select Handle · Selecciona el Tirador

Wood Bambú	Matte Black Negro Mate	Silver Metálico
---------------	---------------------------	--------------------



KC 120 Plancha

Ref BKC0024



SPECIFICATIONS · CARACTERÍSTICAS

Module Measurements Medidas del Módulo	W 118.4 x D 70 x H 92 cm
Countertop Material Material de la Encimera	Neolith sintered stone Piedra sinterizada Neolith
Body Material Material	Ultra durable powder coated stainless steel (Qualisteelcoat) Acero inoxidable con recubrimiento en polvo ultra duradero (Qualisteelcoat)
Number of Doors Número de Puertas	2
Magnetic Close Door Puerta con Cierre Magnético	✓
Soft Close Hinge Bisagras con cierre suave	✓
Gas Bottle Support Soporte Bombona de Gas	✓
Accessible Leveling Feet Pies Niveladores Accesibles	✓

Plancha & End Panels not included
Plancha y End Panels no incluidos

Customise Top Finish · Personaliza la Encimera

Nero Zimbabwe	Basalt Black
Pietra Di Luna	Iron Corten
Iron Frost	Pietra Di Osso
Summer Dala	Barro

Set Cabinet Colour · Define el Color del Módulo

Anthracite Grey Gris Antracita	Pearl White Blanco Perla
-----------------------------------	-----------------------------

Select Handle · Selecciona el Tirador

Wood Bambú	Matte Black Negro Mate	Silver Metálico
---------------	---------------------------	--------------------



CT 80 Kamado

Ref BKC0020



SPECIFICATIONS · CARACTERÍSTICAS

Module Measurements Medidas del Módulo	W 78.4 x D 70 x H 40 cm
Countertop Material Material de la Encimera	Neolith sintered stone Piedra sinterizada Neolith
Body Material Material	Ultra durable powder coated stainless steel (Qualisteelcoat) Acero inoxidable con recubrimiento en polvo ultra duradero (Qualisteelcoat)
Number of Drawers Número de Cajones	1
Soft Close Slides Guías con cierre suave	✓
Accessible Leveling Feet Pies Niveladores Accesibles	✓
Kamado & End Panels not included Kamado y End Panels no incluidos	

Customise Top Finish · Personaliza la Encimera

Nero Zimbawe	Basalt Black
Pietra Di Luna	Iron Corten
Iron Frost	Pietra Di Osso
Summer Dala	Barro

Set Cabinet Colour · Define el Color del Módulo

Anthracite Grey Gris Antracita	Pearl White Blanco Perla
-----------------------------------	-----------------------------

Select Handle · Selecciona el Tirador

Wood Bambú	Matte Black Negro Mate	Silver Metálico
----------------------	----------------------------------	---------------------------



CT 90 Oven

Ref BKC0029

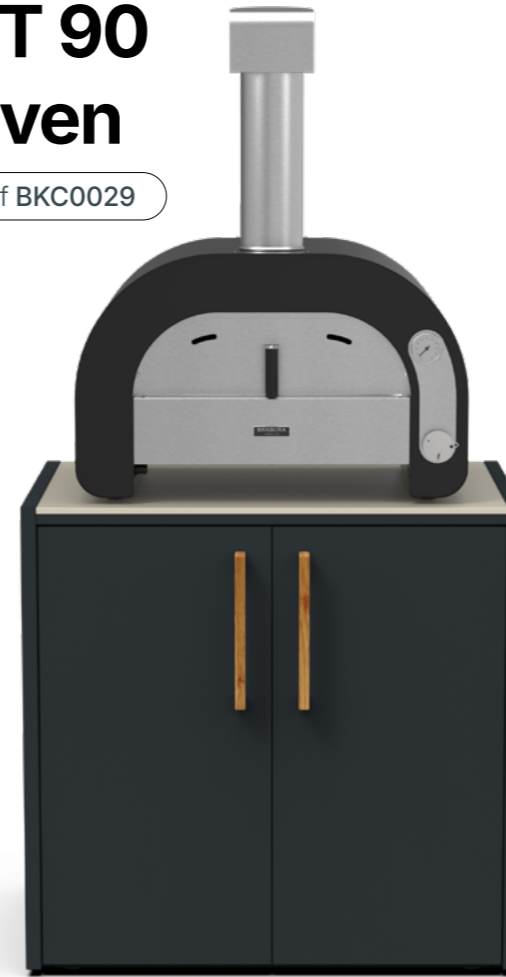

SPECIFICATIONS · CARACTERÍSTICAS

Module Measurements Medidas del Módulo	W 90 x D 70 x H 92 cm
Countertop Material Material de la Encimera	Neolith sintered stone Piedra sinterizada Neolith
Body Material Material	Ultra durable powder coated stainless steel (Qualisteelcoat) Acero inoxidable con recubrimiento en polvo ultra duradero (Qualisteelcoat)
Number of Doors Número de Puertas	2
Magnetic Close Door Puerta con Cierre Magnético	✓
Soft Close Hinge Bisagras con cierre suave	✓
Gas Bottle Support Soporte Bombona de Gas	✓
Accessible Leveling Feet Pies Niveladores Accesibles	✓
Oven & End Panels not included Horno y End Panels no incluidos	

Customise Top Finish · Personaliza la Encimera

Nero Zimbawe	Basalt Black
Pietra Di Luna	Iron Corten
Iron Frost	Pietra Di Osso
Summer Dala	Barro

Set Cabinet Colour · Define el Color del Módulo

Anthracite Grey Gris Antracita	Pearl White Blanco Perla
-----------------------------------	-----------------------------

Select Handle · Selecciona el Tirador

Wood Bambú	Matte Black Negro Mate	Silver Metálico
----------------------	----------------------------------	---------------------------



CT 60 Countertop Side Burners

Ref BKC0025



SPECIFICATIONS · CARACTERÍSTICAS

Module Measurements
Medidas del Módulo

W 65 x D 70 x H 92 cm

Countertop Material
Material de la Encimera

Neolith sintered stone
Piedra sinterizada Neolith

Body Material
Material

Ultra durable powder coated stainless steel (Qualisteelcoat)
Acero inoxidable con recubrimiento en polvo ultra duradero (Qualisteelcoat)

Burners included / End Panels not included
Quemadores incluidos / End Panels no incluidos

BURNERS SPECIFICATIONS CARACTERÍSTICAS DE LOS QUEMADORES

Gas Type
Tipo de Gas

Butane and Propane | Natural Gas
Butano y Propano | Gas Natural

Medium Burner Power
Potencia del Quemador Medio

3.0 kW

Medium Burner Diameter
Diámetro del Quemador Medio

Ø180 mm

Wok/Simmer Burner Power
Potencia del Quemador Wok/Fuego Lento

5.0 kW

Wok/Simmer Burner Diameter
Diámetro del Quemador Wok/Fuego Lento

Ø240 mm



Customise Top Finish · Personaliza la Encimera

 Nero Zimbabwe	 Basalt Black
 Pietra Di Luna	 Iron Corten
 Iron Frost	 Pietra Di Osso
 Summer Dala	 Barro

Set Cabinet Colour · Define el Color del Módulo

 Anthracite Grey Gris Antracita	 Pearl White Blanco Perla
---	---

Select Handle · Selecciona el Tirador

 Wood Bambú	 Matte Black Negro Mate	 Silver Metálico
---	---	--



Utilities Funcionales



CT 60 Fridge

Ref BKC0021



SPECIFICATIONS · CARACTERÍSTICAS

Module Measurements / Medidas del Módulo: **W 65 x D 70 x H 92 cm**

Countertop Material / Material de la Encimera: **Neolith sintered stone** / Piedra sinterizada Neolith

Body Material / Material: **Ultra durable powder coated stainless steel (Qualisteelcoat)** / Acero inoxidable con recubrimiento en polvo ultra duradero (Qualisteelcoat)

End Panels not included · End Panels no incluidos

OUTDOOR FRIDGE SPECIFICATIONS CARACTERÍSTICAS DEL FRIGORÍFICO DE EXTERIOR

Climate Class / Clase Climática: **N-ST**

Capacity / Capacidad: **128L**









Door / Puerta: **Self closing premium triple layer anti-UV frameless full-glass door** / Puerta con cierre automático de vidrio premium de triple capa anti UV sin marco

Temperature Range / Rango Temperatura: **2°C~10°C**

Refrigerant / Refrigerante: **R600a**

Interior Light / Iluminación Interior: **LED**

Customise Top Finish · Personaliza la Encimera

-  Nero Zimbabwe
-  Basalt Black
-  Pietra Di Luna
-  Iron Corten
-  Iron Frost
-  Pietra Di Osso
-  Summer Dala
-  Barro

Cabinet Colour Choice · Elección de Color de Módulo

-  Anthracite Grey / Gris Antracita
-  Pearl White / Blanco Perla

CT 60 Sink

Ref BKC0027



SPECIFICATIONS · CARACTERÍSTICAS

Module Measurements Medidas del Módulo	W 65 x D 70 x H 92 cm
Countertop Material Material de la Encimera	Neolith sintered stone Piedra sinterizada Neolith
Body Material Material	Ultra durable powder coated stainless steel (Qualisteelcoat) Acero inoxidable con recubrimiento en polvo ultra duradero (Qualisteelcoat)
Number of Doors Número de Puertas	1
Magnetic Close Door Puerta con Cierre Magnético	✓
Soft Close Hinge Bisagras con cierre suave	✓
Sink and Faucet Fregadero y Grifo	304 Black Stainless Steel Acero Inoxidable 304 Negro
Accessible Leveling Feet Pies Niveladores Accesibles	✓

End Panels not included · End Panels no incluidos

Customise Top Finish · Personaliza la Encimera

Nero Zimbabwe	Basalt Black
Pietra Di Luna	Iron Corten
Iron Frost	Pietra Di Osso
Summer Dala	Barro

Set Cabinet Colour · Define el Color del Módulo

Anthracite Grey Gris Antracita	Pearl White Blanco Perla
-----------------------------------	-----------------------------

Select Handle · Selecciona el Tirador

Wood Bambú	Matte Black Negro Mate	Silver Metálico
----------------------	----------------------------------	---------------------------



CT 90 Sink

Ref BKC0003



SPECIFICATIONS · CARACTERÍSTICAS

Module Measurements Medidas del Módulo	W 90 x D 70 x H 92 cm
Countertop Material Material de la Encimera	Neolith sintered stone Piedra sinterizada Neolith
Body Material Material	Ultra durable powder coated stainless steel (Qualisteelcoat) Acero inoxidable con recubrimiento en polvo ultra duradero (Qualisteelcoat)
Number of Doors Número de Puertas	2
Magnetic Close Door Puerta con Cierre Magnético	✓
Soft Close Hinge Bisagras con cierre suave	✓
Sink and Faucet Fregadero y Grifo	304 Black Stainless Steel Acero Inoxidable 304 Negro
Accessible Leveling Feet Pies Niveladores Accesibles	✓

End Panels not included · End Panels no incluidos

Customise Top Finish · Personaliza la Encimera

Nero Zimbabwe	Basalt Black
Pietra Di Luna	Iron Corten
Iron Frost	Pietra Di Osso
Summer Dala	Barro

Set Cabinet Colour · Define el Color del Módulo

Anthracite Grey Gris Antracita	Pearl White Blanco Perla
-----------------------------------	-----------------------------

Select Handle · Selecciona el Tirador

Wood Bambú	Matte Black Negro Mate	Silver Metálico
----------------------	----------------------------------	---------------------------



CT 60 Panel Ready Fridge

Module with integrated fridge
Módulo con frigorífico integrado

Ref BKC0035



SPECIFICATIONS · CARACTERÍSTICAS

Module Measurements
Medidas del Módulo

W 65 x D 50 x H 92 cm

Countertop Material
Material de la Encimera

Neolith sintered stone
Piedra sinterizada Neolith

Body Material
Material

Ultra durable powder coated stainless steel (Qualisteelcoat)
Acero inoxidable con recubrimiento en polvo ultra duradero (Qualisteelcoat)

End Panels not included · End Panels no incluidos

OUTDOOR FRIDGE SPECIFICATIONS CARACTERÍSTICAS DEL FRIGORÍFICO DE EXTERIOR

Climate Class
Clase Climática

N-ST

Capacity
Capacidad

128L

Door
Puerta

Self closing door
Puerta con cierre automático

Temperature Range
Rango Temperatura

2°C~10°C

Refrigerant · Refrigerante

R600a

Interior Light
Iluminación Interior

LED

Customise Top Finish · Personaliza la Encimera



Set Cabinet Colour · Define el Color del Módulo



Select Handle · Selecciona el Tirador

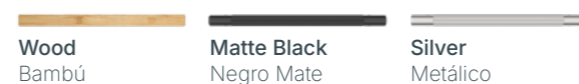

CT 50 Panel Ready Ice Maker

Module with integrated Ice Maker
Módulo con Ice Maker integrado

Ref BKC0025



SPECIFICATIONS · CARACTERÍSTICAS

Module Measurements
Medidas del Módulo

W 43.4 x D 70 x H 92 cm

Countertop Material
Material de la Encimera

Neolith sintered stone
Piedra sinterizada Neolith

Body Material
Material

Ultra durable powder coated stainless steel (Qualisteelcoat)
Acero inoxidable con recubrimiento en polvo ultra duradero (Qualisteelcoat)

Ice production
Producción de hielo

25 kg per day
25 kg por día

Ice storage
Capacidad de almacenamiento

13 kg

Ice type
Tipo de hielo

Cube
Cubo

Cooling system
Sistema de refrigeración

Air cooling
Enfriamiento por aire

End Panels not included · End Panels no incluidos

Customise Top Finish · Personaliza la Encimera



Set Cabinet Colour · Define el Color del Módulo



Select Handle · Selecciona el Tirador



CT 90 Corner

Ref BKC0008

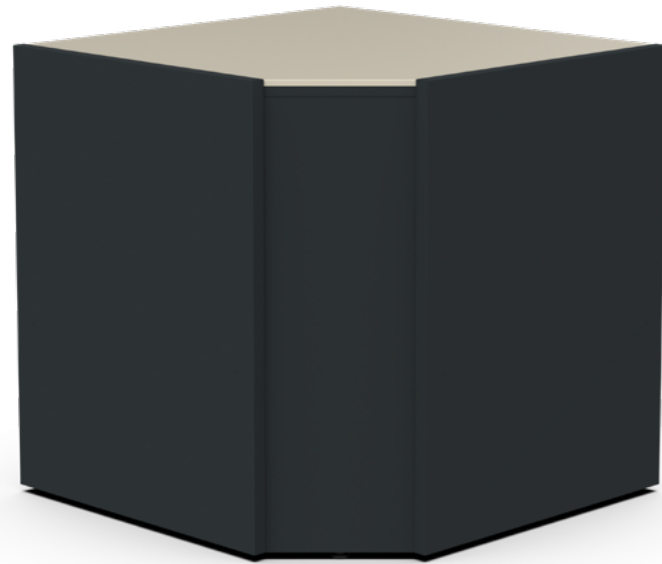

SPECIFICATIONS · CARACTERÍSTICAS

Module Measurements
Medidas del Módulo

W 90 x D 90 x H 92 cm

Countertop Material
Material de la Encimera

Neolith sintered stone
Piedra sinterizada Neolith

Body Material
Material

Ultra durable powder coated stainless steel (Qualisteelcoat)
Acero inoxidable con recubrimiento en polvo ultra duradero (Qualisteelcoat)

Accessible Leveling Feet ✓
Pies Niveladores Accesibles

End Panels not included · End Panels no incluidos

CT 90 Plant Corner

Ref BKC0038



SPECIFICATIONS · CARACTERÍSTICAS

Module Measurements
Medidas del Módulo

W 90 x D 90 x H 92 cm

Countertop Material
Material de la Encimera

Neolith sintered stone
Piedra sinterizada Neolith

Body Material
Material

Ultra durable powder coated stainless steel (Qualisteelcoat)
Acero inoxidable con recubrimiento en polvo ultra duradero (Qualisteelcoat)

Accessible Leveling Feet ✓
Pies Niveladores Accesibles

End Panels not included · End Panels no incluidos

Customise Top Finish · Personaliza la Encimera



Set Cabinet Colour · Define el Color del Módulo



Select Handle · Selecciona el Tirador

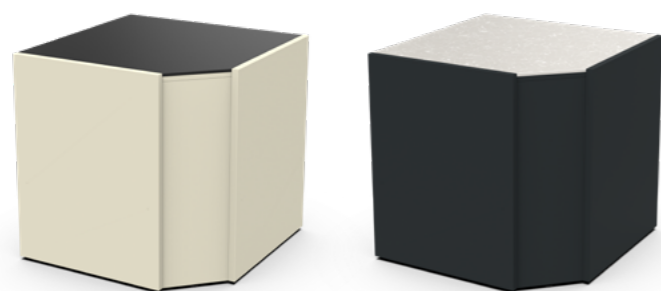
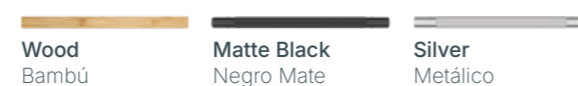

Customise Top Finish · Personaliza la Encimera

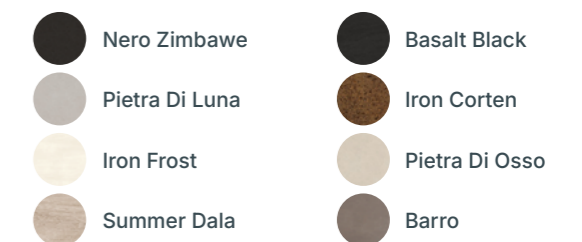

Set Cabinet Colour · Define el Color del Módulo



Select Handle · Selecciona el Tirador

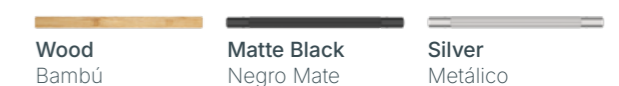

CT 90 Ice Cube Bin Corner

Ref BKC0037



SPECIFICATIONS · CARACTERÍSTICAS

Module Measurements Medidas del Módulo	W 90 x D 90 x H 92 cm
Countertop Material Material de la Encimera	Neolith sintered stone Piedra sinterizada Neolith
Body Material Material	Ultra durable powder coated stainless steel (Qualisteelcoat) Acero inoxidable con recubrimiento en polvo ultra duradero (Qualisteelcoat)
Ice bin material Material del depósito de hielo	Black stainless steel Acero inoxidable negro
Capacity Capacidad	16 L
Hinge cover Cubierta de bisagra	✓
Insulation foam Espuma aislante	✓
Drainer Drenaje	✓

End Panels not included · End Panels no incluidos

Customise Top Finish · Personaliza la Encimera

● Nero Zimbawe	● Basalt Black
● Pietra Di Luna	● Iron Corten
● Iron Frost	● Pietra Di Osso
● Summer Dala	● Barro

Set Cabinet Colour · Define el Color del Módulo

● Anthracite Grey Gris Antracita	● Pearl White Blanco Perla
-------------------------------------	-------------------------------

Select Handle · Selecciona el Tirador

Wood Bambú	Matte Black Negro Mate	Silver Metálico
---------------	---------------------------	--------------------



CT 60 Ice Cube Bin

Ref BKC0039

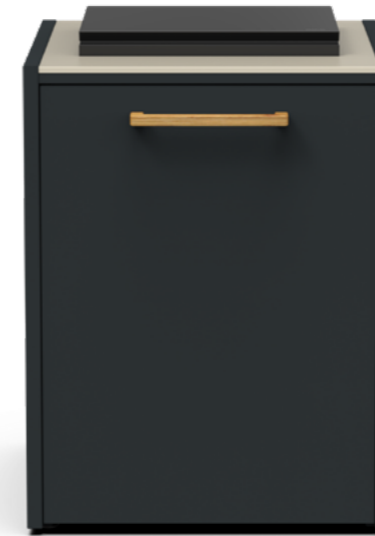

SPECIFICATIONS · CARACTERÍSTICAS

Module Measurements Medidas del Módulo	W 65 x D 70 x H 90 cm
Countertop Material Material de la Encimera	Neolith sintered stone Piedra sinterizada Neolith
Body Material Material	Ultra durable powder coated stainless steel (Qualisteelcoat) Acero inoxidable con recubrimiento en polvo ultra duradero (Qualisteelcoat)
Number of Doors Número de Puertas	1
Magnetic Close Door Puerta con Cierre Magnético	✓
Soft Close Hinge Bisagras con cierre suave	✓
Ice bin material Material del depósito de hielo	Black stainless steel Acero inoxidable negro
Capacity Capacidad	16 L
Hinge cover Cubierta de bisagra	✓
Insulation foam Espuma aislante	✓
Drainer Drenaje	✓
Accessible Leveling Feet Pies Niveladores Accesibles	✓

End Panels not included · End Panels no incluidos

Customise Top Finish · Personaliza la Encimera

● Nero Zimbawe	● Basalt Black
● Pietra Di Luna	● Iron Corten
● Iron Frost	● Pietra Di Osso
● Summer Dala	● Barro

Set Cabinet Colour · Define el Color del Módulo

● Anthracite Grey Gris Antracita	● Pearl White Blanco Perla
-------------------------------------	-------------------------------

Select Handle · Selecciona el Tirador

Wood Bambú	Matte Black Negro Mate	Silver Metálico
---------------	---------------------------	--------------------



Storage Almacenamiento

CT 60 Worktop

Ref BKC0030

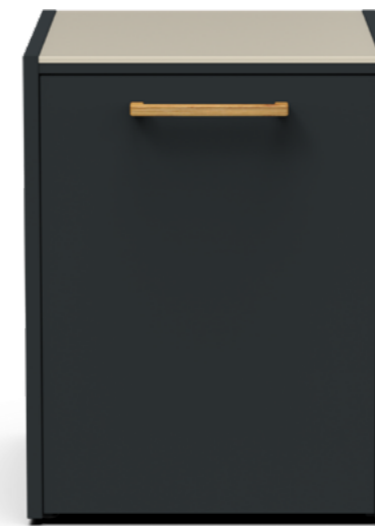

SPECIFICATIONS · CARACTERÍSTICAS

Module Measurements Medidas del Módulo	W 65 x D 70 x H 92 cm
Countertop Material Material de la Encimera	Neolith sintered stone Piedra sinterizada Neolith
Body Material Material	Ultra durable powder coated stainless steel (Qualisteelcoat) Acero inoxidable con recubrimiento en polvo ultra duradero (Qualisteelcoat)
Number of Doors Número de Puertas	1
Magnetic Close Door Puerta con Cierre Magnético	✓
Full Depth Shelf Estantes Intermedios	1
Soft Close Hinge Bisagras con cierre suave	✓
Accessible Leveling Feet Pies Niveladores Accesibles	✓

End Panels not included · End Panels no incluidos

Customise Top Finish · Personaliza la Encimera

Nero Zimbabwe	Basalt Black
Pietra Di Luna	Iron Corten
Iron Frost	Pietra Di Osso
Summer Dala	Barro

Set Cabinet Colour · Define el Color del Módulo

Anthracite Grey Gris Antracita	Pearl White Blanco Perla
-----------------------------------	-----------------------------

Select Handle · Selecciona el Tirador

Wood Bambú	Matte Black Negro Mate	Silver Metálico
----------------------	----------------------------------	---------------------------

CT 60 Trash Drawers

Ref BKC0002



SPECIFICATIONS · CARACTERÍSTICAS

Module Measurements
Medidas del Módulo

W 65 x D 70 x H 92 cm

Countertop Material
Material de la Encimera

Neolith sintered stone
Piedra sinterizada Neolith

Body Material
Material

Ultra durable powder coated stainless steel (Qualisteelcoat)
Acero inoxidable con recubrimiento en polvo ultra duradero (Qualisteelcoat)

Number of Drawers
Número de Cajones

2

Bins / Capacity
Cubos de basura / Capacidad

2 / 40L

Capacity
Capacidad

80L

Soft Close Slides
Guías con cierre suave

✓

Accessible Leveling Feet
Pies Niveladores Accesibles

✓

End Panels not included · End Panels no incluidos

Customise Top Finish · Personaliza la Encimera



Set Cabinet Colour · Define el Color del Módulo



Select Handle · Selecciona el Tirador

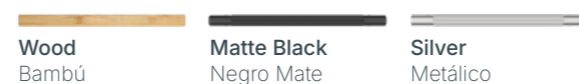

CT 60 Drawers

Ref BKC0026

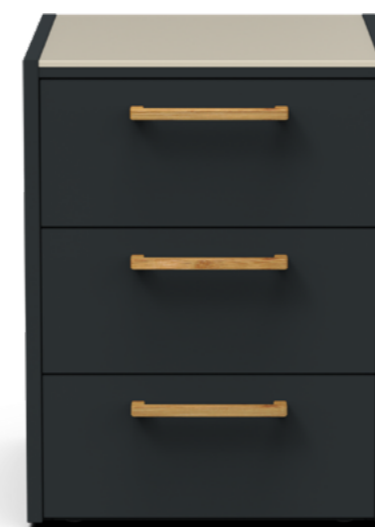

SPECIFICATIONS · CARACTERÍSTICAS

Module Measurements
Medidas del Módulo

W 65 x D 70 x H 92 cm

Countertop Material
Material de la Encimera

Neolith sintered stone
Piedra sinterizada Neolith

Body Material
Material

Ultra durable powder coated stainless steel (Qualisteelcoat)
Acero inoxidable con recubrimiento en polvo ultra duradero (Qualisteelcoat)

Number of Drawers
Número de Cajones

3

Soft Close Slides
Guías con cierre suave

✓

Accessible Leveling Feet
Pies Niveladores Accesibles

✓

End Panels not included · End Panels no incluidos

Customise Top Finish · Personaliza la Encimera



Set Cabinet Colour · Define el Color del Módulo



Select Handle · Selecciona el Tirador

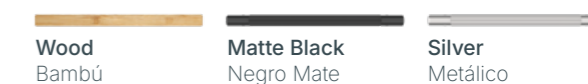

CT 90 Drawers

Ref BKC0001



SPECIFICATIONS · CARACTERÍSTICAS

Module Measurements
Medidas del Módulo

W 90 x D 70 x H92 cm

Countertop Material
Material de la Encimera

Neolith sintered stone
Piedra sinterizada Neolith

Body Material
Material

Ultra durable powder coated stainless steel (Qualisteelcoat)
Acero inoxidable con recubrimiento en polvo ultra duradero (Qualisteelcoat)

Number of Drawers
Número de Cajones

3

Soft Close Slides
Guías con cierre suave

✓

Accessible Leveling Feet
Pies Niveladores Accesibles

✓

End Panels not included · End Panels no incluidos

CT 90 Open

Ref BKC0004



SPECIFICATIONS · CARACTERÍSTICAS

Module Measurements
Medidas del Módulo

W 90 x D 70 x H 92 cm

Countertop Material
Material de la Encimera

Neolith sintered stone
Piedra sinterizada Neolith

Body Material
Material

Ultra durable powder coated stainless steel (Qualisteelcoat)
Acero inoxidable con recubrimiento en polvo ultra duradero (Qualisteelcoat)

Full Depth Shelf
Estantes Intermedios

Bamboo wood (standard) or Neolith stone (optional)
Madera de bambú (estándar) o piedra Neolith (opcional)

Accessible Leveling Feet
Pies Niveladores Accesibles

✓

End Panels not included · End Panels no incluidos



Customise Top Finish · Personaliza la Encimera

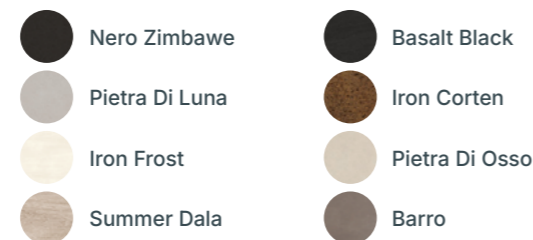

Set Cabinet Colour · Define el Color del Módulo



Select Handle · Selecciona el Tirador

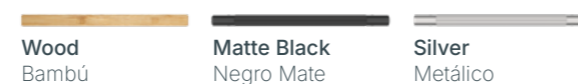

Customise Top Finish · Personaliza la Encimera



Set Cabinet Colour · Define el Color del Módulo



Select Handle · Selecciona el Tirador



Neolith, your safest kitchen countertop choice

IRON¹
NEOLITH

«The evolution of metal»

Iron behaves in a unique way - sometimes shiny and gleaming, and at other times, rusted and patinated.

Neolith's Iron surfaces deliver a singular and highly original look which celebrates the dual aspect of this material. These richly detailed designs, some subtle and others vibrant, reflect an understanding of modern aesthetic tastes.

The Iron collection mimics the real material but delivers enhanced resistance qualities, which guarantee a greater degree of performance and longevity.

IRON FROST



IRON CORTEN



NEOLITH
touch.feel.live

«La evolución del metal»

El hierro se comporta de una manera única: a veces brillante y reluciente, y en otras ocasiones, oxidado y con pátina.

Las superficies Neolith Iron ofrecen una estética singular y altamente original que celebra la dualidad de este material. Estos diseños ricamente detallados, algunos sutiles y otros vibrantes, reflejan una profunda comprensión de los gustos estéticos contemporáneos.

La colección Iron reproduce fielmente la apariencia del material real, al tiempo que incorpora cualidades de resistencia mejoradas, garantizando un mayor nivel de rendimiento y durabilidad.

Neolith, la opción de encimera de cocina más segura

TIMBER
NEOLITH

«The natural selections»

Natural wood, although beautiful, has always been difficult to specify for certain interior and exterior applications. Its high porosity makes it unsuitable for any environment in which there are large amounts of water and its susceptibility to staining means extra special care needs to be taken when using it as a surface.

Neolith has pioneered a faithful and hyper-realistic range of slabs which solves this problem. This means you can have wood-effect surfaces throughout the house with all the physical and mechanical advantages offered by sintered stone.

Unlike natural wood, Neolith's Timber collection requires zero maintenance or treatment to enhance its performance or improve its resistance.

This means that it can handle the rigors of everyday life without any wear and tear.

«Las selecciones naturales»

La madera natural, además de bella siempre ha sido difícil de especificar para ciertos interiores y exteriores. Su alta porosidad la hace no apta para cualquier entorno con humedad y su susceptibilidad a mancharse requiere un cuidado especial cuando se utiliza como recubrimiento.

Neolith presenta unas tablas hiper-realistas que solucionan este problema. Esto significa que puedes instalar superficies efecto madera por toda la casa con todas las ventajas físicas y mecánicas de la piedra sinterizada.

La colección Timber de Neolith, al contrario que la madera natural, no necesita ningún mantenimiento para mejorar su rendimiento o resistencia.

¡Olvídate de desperfectos y desgaste por el uso del día a día!

SUMMER DALA*

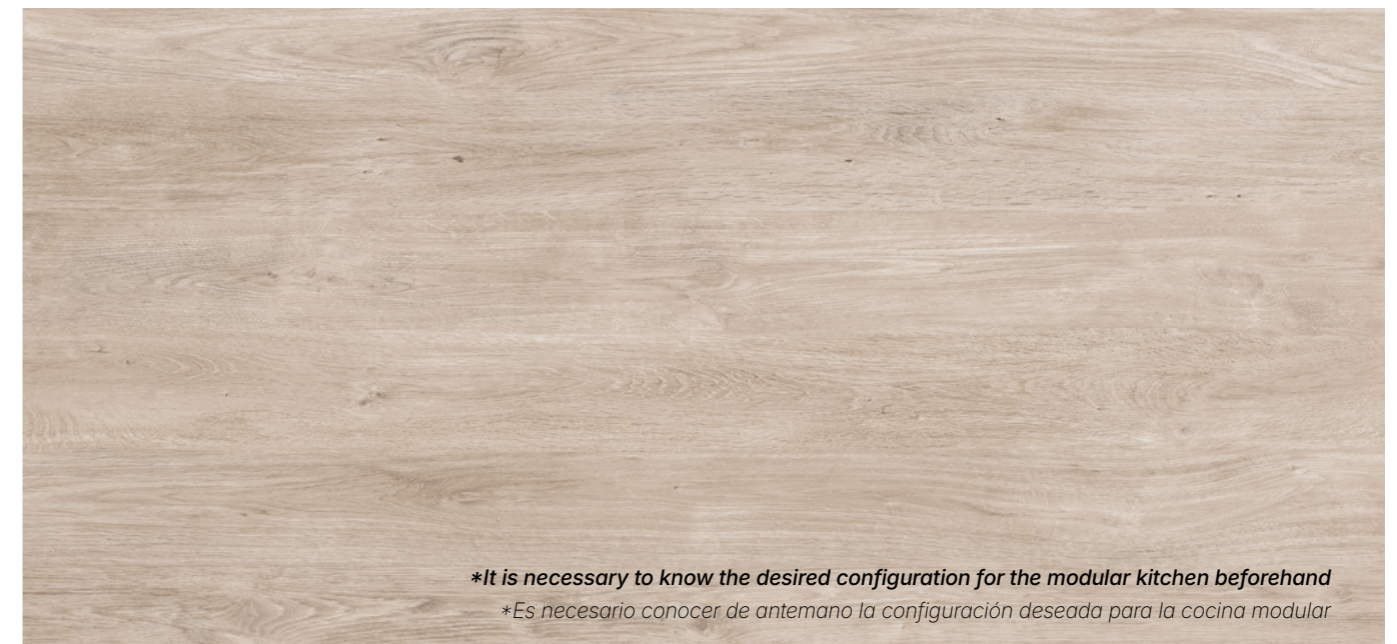

**It is necessary to know the desired configuration for the modular kitchen beforehand
Es necesario conocer de antemano la configuración deseada para la cocina modular

FUSION

NEOLITH

«The shock of the new»

The Fusion collection is the result of our designers' quest to blend traditional and contemporary.

Neolith is looking to combine both classic style and emergent trends, creating a collection which showcases our conceptual creativity.

These unique patterns playfully reference materials found in the natural world, with a modern twist. Incorporating the industrial, the organic and the futuristic, the Fusion collection offers an interpretation of Neolith which will inspire, excite and entice.

«El shock de lo nuevo»

La colección Fusion es el resultado de la búsqueda de nuestros diseñadores para combinar lo tradicional y lo contemporáneo.

Neolith busca el estilo clásico y las tendencias emergentes, creando una colección que muestra nuestra creatividad conceptual. Estos diseños únicos hacen referencia a los materiales encontrados en el mundo natural, con un toque moderno.

Incorporando lo industrial, lo orgánico y lo futurista, la colección Fusion ofrece una interpretación de Neolith que inspirará, entusiasmará y seducirá.

BASALT BLACK*

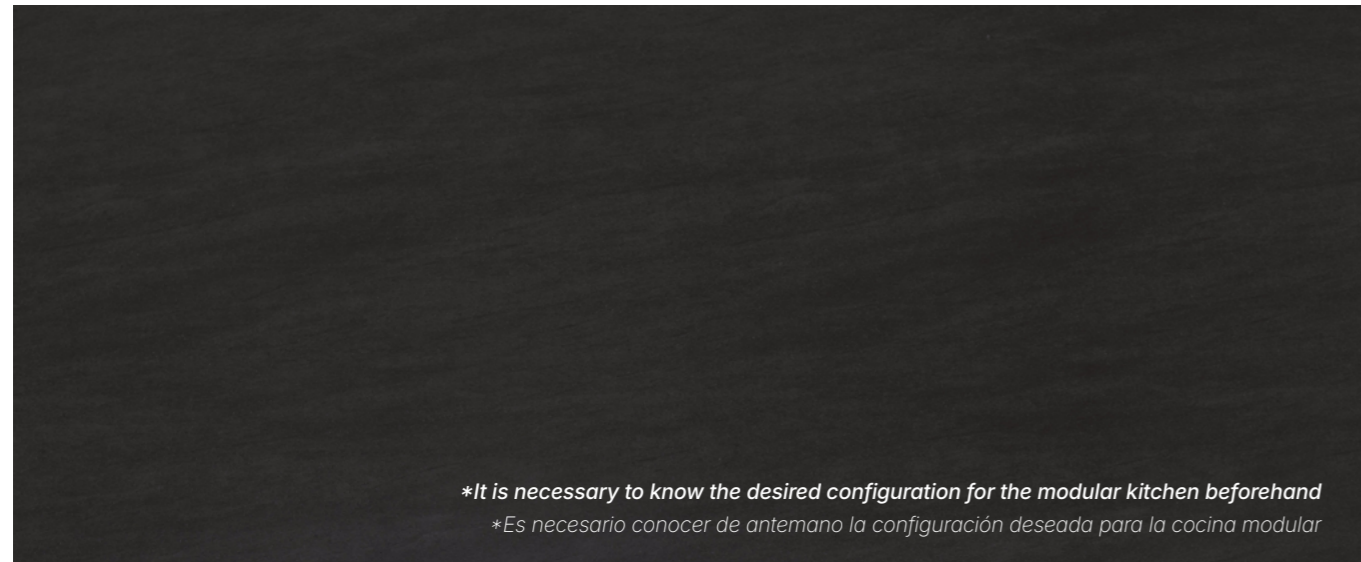

PIETRA DI LUNA

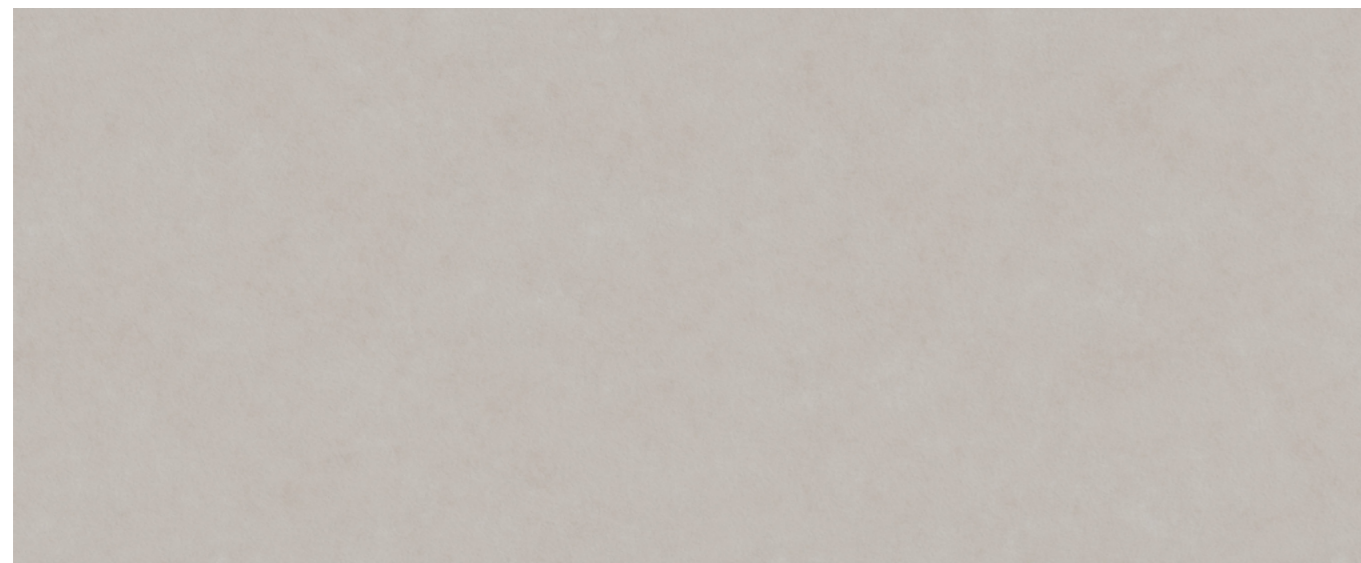

BARRO



NERO ZIMBAWE

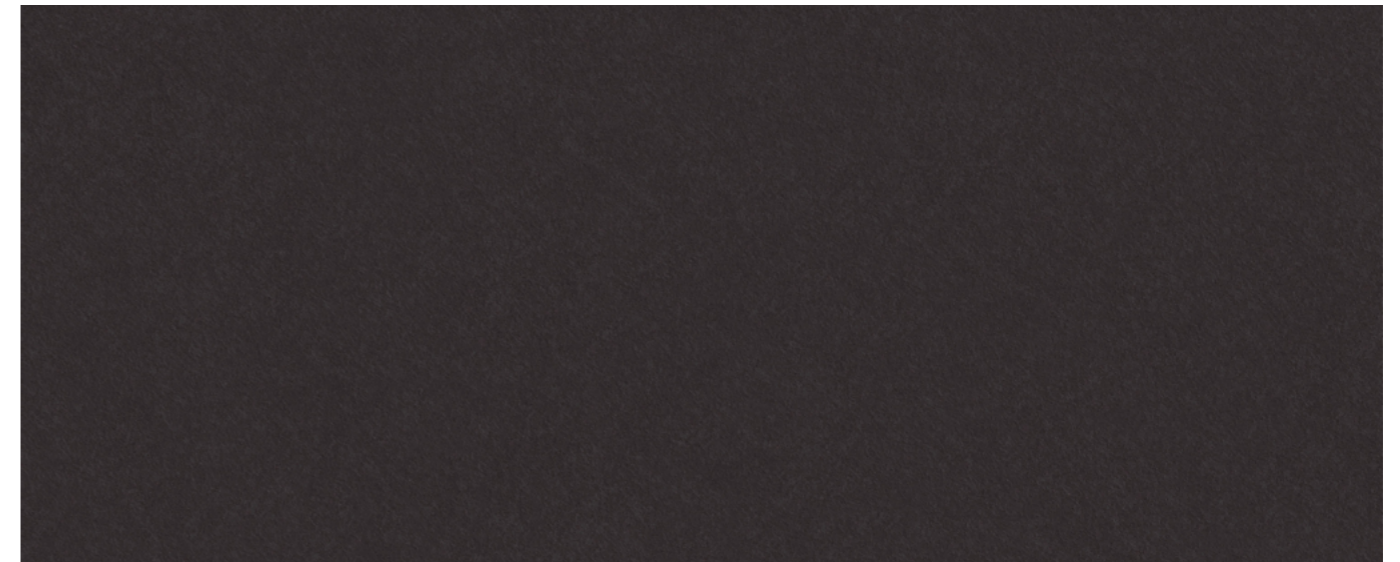

PIETRA DI OSSO

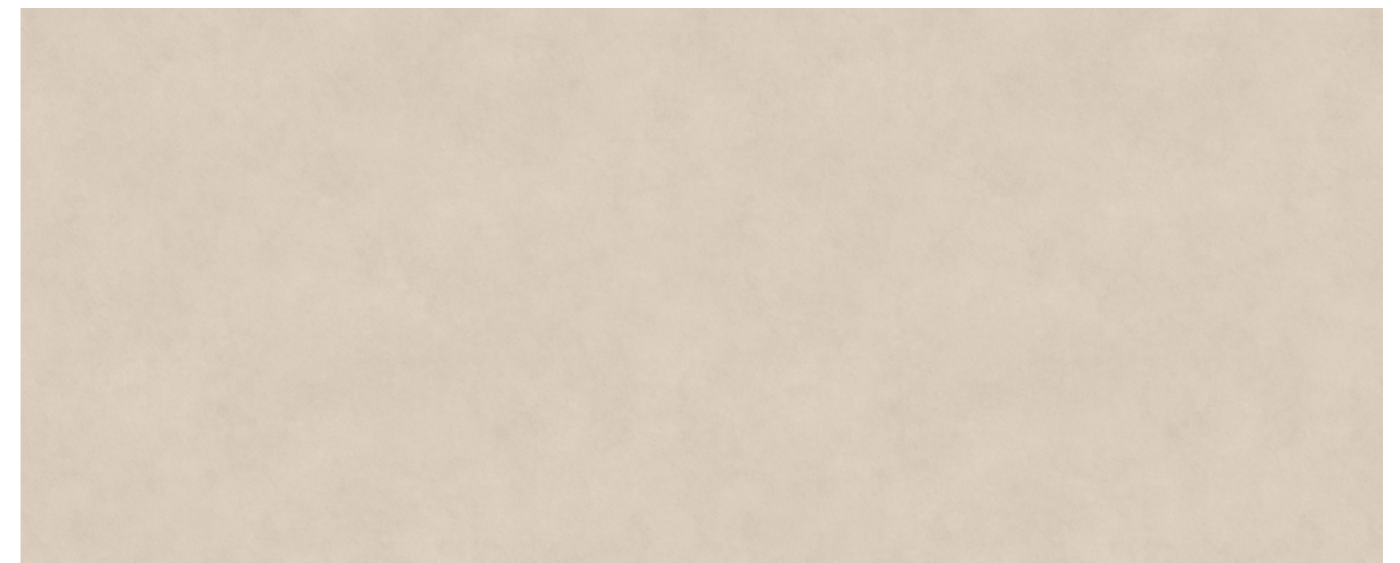

Enhancing Your Outdoor Kitchen Luxury Handles for Exclusive Modules

Refina tu Cocina al Aire Libre Tiradores de Lujo para Módulos Exclusivos

Discover the elegance and functionality in every detail of our outdoor kitchens with the exclusive handles we offer! We have designed three exceptional options to complement your kitchen modules, providing not only an impressive aesthetic touch but also a premium experience with each use.

Marine Varnish Treated Bamboo Handle:

Immerse yourself in the harmony of nature with our bamboo handle. The warmth of the bamboo, combined with its natural strength, creates a perfect balance of aesthetics and durability. Treated with marine varnish for enhanced resistance to weather conditions, the bamboo ensures exceptional longevity and retains its impeccable appearance over time.

Metallic Handle in Stainless Steel and Black Stainless Steel with Premium Knurling:

Experience luxury with every grip with our metallic handles. Available in two elegant finishes, stainless steel and black stainless steel, these handles add a modern and sophisticated touch to your outdoor kitchen. The knurling in the central part not only improves grip but also adds a touch of exclusivity, enhancing the aesthetics of your outdoor space.

In our commitment to offering high-quality products, these handles are not only a visually appealing complement but are also designed to withstand the changing conditions of the outdoor environment. Durability and style come together in every detail, creating a unique and pleasant atmosphere in your outdoor space.

Turn every moment in the kitchen into a unique experience with our premium handles. Discover the perfect fusion of functionality and aesthetics, elevating the level of your outdoor kitchen to new heights. Make your outdoor space a place where design, durability, and resistance come together in perfect harmony.

Descubra la elegancia y la funcionalidad en cada detalle de nuestras cocinas exteriores con las manijas exclusivas que ofrecemos. Hemos diseñado tres opciones excepcionales para complementar sus módulos de cocina, ofreciendo no solo un toque estético impresionante, sino también una experiencia premium en cada uso.

Manija De Bambú Tratada Con Barniz Marino:

Sumérgase en la armonía de la naturaleza con nuestra manija de bambú. La calidez del bambú, combinada con su robustez natural, crea un equilibrio perfecto entre estética y durabilidad. Tratado con un barniz marino para una resistencia aumentada a las inclemencias del tiempo, el bambú garantiza una longevidad excepcional mientras conserva su apariencia impecable con el paso del tiempo.

Manija Metálica De Acero Inoxidable E Inox Negro Con Moleteado Premium:

Experimente el lujo en cada agarre con nuestras manijas metálicas. Disponibles en dos acabados elegantes, inox e inox negro, estas manijas aportan un toque moderno y sofisticado a su cocina exterior. El moleteado en el centro mejora no solo el agarre, sino que también añade un toque de exclusividad, elevando la estética de su espacio exterior.

En nuestro compromiso por ofrecer productos de alta calidad, estas manijas no son solo un complemento visualmente atractivo, sino que también están diseñadas para resistir las condiciones cambiantes del entorno exterior. La durabilidad y el estilo se combinan en cada detalle, creando una atmósfera única y agradable en su espacio exterior.

Transforme cada momento en la cocina en una experiencia única con nuestras manijas de primera calidad. Descubra la fusión perfecta entre funcionalidad y estética, elevando el nivel de su cocina exterior a nuevas alturas. ¡Haga de su espacio exterior un lugar donde el diseño, la durabilidad y la resistencia se encuentran en perfecta armonía!



LITE Series Kitchens

Cocinas LITE Series



LITE Series 300

Compact · Compacta

Ref BKC0033



SPECIFICATIONS · CARACTERÍSTICAS

Total Measurements Medidas Totales	W 159 x D 62.5 x H 92.3 cm
Grill included Barbacoa incluida	Fusion 300 LITE
Fridge included Frigorífico incluido	Outdoor Fridge, 60 L Capacity Frigorífico de exterior con capacidad 60 L
Countertop Material Material de la Encimera	Sintered stone Piedra sinterizada
Body Material Material	Ultra durable powder coated galvanized steel (Qualisteelcoat) Acero galvanizado con recubrimiento en polvo ultra duradero (Qualisteelcoat)
Sink and Faucet Fregadero y Grifo	304 Stainless Steel Acero Inoxidable 304
Bins / Capacity Cubos de basura / Capacidad	1 / 40L
Magnetic Close Door Puertas con Cierre Magnético	✓
Soft Close Hinge Bisagras con cierre suave	304 Stainless Steel Acero Inoxidable 304
Gas Bottle Support Soporte Bombona de Gas	✓
Hidden Wheels & Lock-Down Legs Patas Ocultas con Ruedas y Bloqueo	✓

Premium black stainless-steel grill: powerful heat and sleek finish.
Parrilla premium de acero inoxidable negro: calor potente y acabado elegante.

Sink & trash bin: streamlined prep and cleanup in one place.
Fregadero y cubo de basura: preparación y limpieza en un solo lugar, de forma práctica.



Ample storage capacity: spacious cabinets and drawers keep everything organized.
Gran capacidad de almacenamiento: armarios y cajones espaciosos para mantener todo organizado.

60 L integrated fridge: keeps ingredients and beverages perfectly chilled.
Frigorífico integrado de 60 L: mantiene ingredientes y bebidas perfectamente fríos.

Durable powder-coated, galvanized frame: weather-resistant toughness.

Estructura galvanizada con recubrimiento en polvo: durabilidad y resistencia a la intemperie.

Built-in bottle opener: always within reach for refreshment breaks.
Abrebotellas integrado: siempre a mano para tus momentos de descanso.



Hidden wheels & lock-down legs: roll it where you need it, then secure it into a rock-solid workstation.
Ruedas ocultas y patas bloqueables: muévelo donde lo necesites y fíjalo como una estación de trabajo sólida.



LITE Series 400

Compact · Compacta

Ref BKC0032



SPECIFICATIONS · CARACTERÍSTICAS

Total Measurements Medidas Totales	W 222.5 x D 62.5 x H 92 cm
Grill included Barbacoa incluida	Fusion 400 LITE
Fridge included Frigorífico incluido	Outdoor Fridge, 60 L Capacity Frigorífico de exterior con capacidad 60 L
Countertop Material Material de la Encimera	Sintered stone Piedra sinterizada
Body Material Material	Ultra durable powder coated galvanized steel (Qualisteelcoat) Acero galvanizado con recubrimiento en polvo ultra duradero (Qualisteelcoat)
Sink and Faucet Fregadero y Grifo	304 Stainless Steel Acero Inoxidable 304
Bins / Capacity Cubos de basura / Capacidad	1 / 40L
Magnetic Close Door Puertas con Cierre Magnético	✓
Soft Close Hinge Bisagras con cierre suave	304 Stainless Steel Acero Inoxidable 304
Gas Bottle Support Soporte Bombona de Gas	✓
Hidden Wheels & Lock-Down Legs Patatas Ocultas con Ruedas y Bloqueo	✓
Side Burner Quemador lateral	3.81 kW

Premium black stainless-steel grill: powerful heat and sleek finish.
Parrilla premium de acero inoxidable negro: calor potente y acabado elegante.

Sink & trash bin: streamlined prep and cleanup in one place.
Fregadero y cubo de basura: preparación y limpieza en un solo lugar, de forma práctica.



Ample storage capacity: spacious cabinets and drawers keep everything organized.

Gran capacidad de almacenamiento: armarios y cajones espaciosos para mantener todo organizado.

60 L integrated fridge: keeps ingredients and beverages perfectly chilled.
Frigorífico integrado de 60 L: mantiene ingredientes y bebidas perfectamente fríos.

High-output side burner: extra cooking zone for sauces or sides.
Quemador lateral de alta potencia: zona de cocción adicional para salsas o guarniciones.

Built-in bottle opener: always within reach for refreshment breaks.
Abrebotellas integrado: siempre a mano para tus momentos de descanso.



Hidden wheels & lock-down legs: roll it where you need it, then secure it into a rock-solid workstation.

Ruedas ocultas y patas bloqueables: muévelo donde lo necesites y fíjalo como una estación de trabajo sólida.

Durable powder-coated, galvanized frame: weather-resistant toughness.

Estructura galvanizada con recubrimiento en polvo: durabilidad y resistencia a la intemperie.



Grills

Barbacoas



Box-Q

Built-In · Encastrada

Ref BGG0018



SPECIFICATIONS · CARACTERÍSTICAS

Dimensions · Medidas	W 103.4 x D 62.3 x H 88.3 cm
Grates Material · Material de la Rejilla	Polished Stainless Steel 304 · Acero inoxidable 304 Pulido
Grates Thickness · Espesor de la Rejilla	10.0 mm
Cooking Surface Dimension · Superficie de Cocción	3.540 cm ² 77×46 cm
Cut-out Dimensions · Dimensiones del Hueco para Encastrar	W 102.5 x D 52 x H 24 cm
Capacity · Capacidad	Suitable for 10-15 people · Recomendada para 10-15 personas
Control Panel Material · Material del Panel de Control	Ultra durable powder coated stainless steel Acero inoxidable con recubrimiento en polvo ultra duradero
Grill Hood Material · Material de la Tapa del Grill	Ultra durable powder coated stainless steel Acero inoxidable con recubrimiento en polvo ultra duradero
Grill Hood Extras · Extras de la Tapa del Grill	Thermal Insulation and Silicone Seal Aislamiento Térmico y Junta de Silicona
Chassis Material · Material del Chasis	304 Stainless Steel · Acero Inoxidable 304
Burner Material · Material de los Quemadores	Cast Stainless Steel · Acero Inoxidable Fundido
Gas Type · Tipo de Gas	Butane and Propane Natural Gas · Butano y Propano Gas Natural
No of Burners / Power · Nº de Quemadores / Potencia	4 / 4.0 kW
Power · Potencia	16.0 kW
Ignition Type · Tipo de Encendido	Continuous Spark · Piezoeléctrico Automático
Weight · Peso	80 Kg

Box-Q S

Built-In · Encastrada

Ref BGG0024



SPECIFICATIONS · CARACTERÍSTICAS

Dimensions · Medidas	W 103.4 x D 62.3 x H 88.3 cm
Grates Material · Material de la Rejilla	Polished Stainless Steel 304 · Acero inoxidable 304 Pulido
Grates Thickness · Espesor de la Rejilla	10.0 mm
Cooking Surface Dimension · Superficie de Cocción	3.540 cm ² 77×46 cm
Cut-out Dimensions · Dimensiones del Hueco para Encastrar	W 102.5 x D 52 x H 24 cm
Capacity · Capacidad	Suitable for 10-15 people · Recomendada para 10-15 personas
Control Panel Material · Material del Panel de Control	304 Stainless Steel · Acero Inoxidable 304
Grill Hood Material · Material de la Tapa del Grill	304 Stainless Steel · Acero Inoxidable 304
Grill Hood Extras · Extras de la Tapa del Grill	Thermal Insulation and Silicone Seal Aislamiento Térmico y Junta de Silicona
Chassis Material · Material del Chasis	304 Stainless Steel · Acero Inoxidable 304
Burner Material · Material de los Quemadores	Cast Stainless Steel · Acero Inoxidable Fundido
Gas Type · Tipo de Gas	Butane and Propane Natural Gas · Butano y Propano Gas Natural
No of Burners / Power · Nº de Quemadores / Potencia	4 / 4.0 kW
Power · Potencia	16.0 kW
Ignition Type · Tipo de Encendido	Continuous Spark · Piezoeléctrico Automático
Weight · Peso	80 Kg

Fusion 400 RS

Built-In and Portable
Encastrada y Portátil

Ref BGG0013



Fusion 500 RS

Built-In and Portable
Encastrada y Portátil

Ref BGG0014



SPECIFICATIONS · CARACTERÍSTICAS	Fusion 400 RS & Fusion 500 RS
Grates Material Material de la Rejilla	304 Stainless Steel Acero Inoxidable 304
Grates Thickness Espesor de la Rejilla	10.0 mm
Control Panel Material Material del Panel de Control	304 Stainless Steel Acero Inoxidable 304
Grill Hood Material Material de la Tapa del Grill	304 Stainless Steel Acero Inoxidable 304
Chassis Material Material del Chasis	304 Stainless Steel Acero Inoxidable 304
Burner Material Material de los Quemadores	Cast Stainless Steel Acero Inoxidable Fundido
Gas Type Tipo de Gas	Butane and Propane Natural Gas Butano y Propano Gas Natural
Ignition Type Tipo de Encendido	Piezoelectric Piezoeléctrico
Knobs Mandos de Control	LED-lit, Orange White Iluminación LED, Naranja Blanco

SPECIFICATIONS · CARACTERÍSTICAS	Fusion 400 RS	Fusion 500 RS
Dimensions Medidas	W 82.4 x D 66.6 x H 78.3 cm	W 100.8 x D 66.6 x H 78.3 cm
Cooking Surface Dimension Superficie de Cocción	3.540 cm² 77x46 cm	4.370 cm² 95x46 cm
Cut-out Dimensions Dimensiones del Hueco para Encastrar	W 78 x D 54 x H 21 cm	W 97 x D 54 x H 21 cm
Capacity Capacidad	Suitable for 10-15 people Recomendada para 10-15 personas	Suitable for 15-20 people Recomendada para 15-20 personas
No of Burners / Power Nº de Quemadores / Potencia	4 / 3.81 kW	5 / 3.81 kW
Power Potencia	19.05 kW	22.86 kW
Infrared Rear Burner / Power Quemador Trasero / Potencia	✓ / 3.81 kW	✓ / 3.81 kW
Weight Peso	63.7 Kg	73.8 Kg

Fusion 400 RM

Built-In and Portable
Encastrada y Portátil

Ref BGG0015



Fusion 500 RM

Built-In and Portable
Encastrada y Portátil

Ref BGG0016



SPECIFICATIONS · CARACTERÍSTICAS	Fusion 400 RM & Fusion 500 RM
Grates Material Material de la Rejilla	304 Stainless Steel Acero Inoxidable 304
Grates Thickness Espesor de la Rejilla	10.0 mm
Control Panel Material Material del Panel de Control	Ultra durable powder coated stainless steel Acero inoxidable con recubrimiento en polvo ultra duradero
Grill Hood Material Material de la Tapa del Grill	Ultra durable powder coated stainless steel Acero inoxidable con recubrimiento en polvo ultra duradero
Chassis Material Material del Chasis	304 Stainless Steel Acero Inoxidable 304
Burner Material Material de los Quemadores	Cast Stainless Steel Acero Inoxidable Fundido
Gas Type Tipo de Gas	Butane and Propane Natural Gas Butano y Propano Gas Natural
Ignition Type Tipo de Encendido	Piezoelectric Piezoeléctrico
Knobs Mandos de Control	LED-lit, Orange White Iluminación LED, Naranja Blanco

SPECIFICATIONS · CARACTERÍSTICAS	Fusion 400 RM	Fusion 500 RM
Dimensions Medidas	W 82.4 x D 66.6 x H 78.3 cm	W 100.8 x D 66.6 x H 78.3 cm
Cooking Surface Dimension Superficie de Cocción	3.540 cm² 77×46 cm	4.370 cm² 95×46 cm
Cut-out Dimensions Dimensiones del Hueco para Encastrar	W 78 x D 54 x H 21 cm	W 97 x D 54 x H 21 cm
Capacity Capacidad	Suitable for 10-15 people Recomendada para 10-15 personas	Suitable for 15-20 people Recomendada para 15-20 personas
No of Burners / Power Nº de Quemadores / Potencia	4 / 3.81 kW	5 / 3.81 kW
Power Potencia	19.05 kW	22.86 kW
Infrared Rear Burner / Power Quemador Trasero / Potencia	✓ / 3.81 kW	✓ / 3.81 kW
Weight Peso	63.7 Kg	73.8 Kg

Fusion 300 LITE

Built-In and Portable
Encastrada y Portátil

Ref BGG0027



Fusion 400 LITE

Built-In and Portable
Encastrada y Portátil

Ref BGG0026



SPECIFICATIONS · CARACTERÍSTICAS	Fusion 300 LITE & Fusion 400 LITE
Grates Material Material de la Rejilla	304 Stainless Steel Acero Inoxidable 304
Grates Thickness Espesor de la Rejilla	8.0 mm
Control Panel Material Material del Panel de Control	Ultra durable powder coated stainless steel Acero inoxidable con recubrimiento en polvo ultra duradero
Grill Hood Material Material de la Tapa del Grill	Ultra durable powder coated stainless steel Acero inoxidable con recubrimiento en polvo ultra duradero
Chassis Material Material del Chasis	Stainless Steel Acero Inoxidable
Burner Material Material de los Quemadores	Cast Stainless Steel Acero Inoxidable Fundido
Gas Type Tipo de Gas	Butane and Propane Natural Gas Butano y Propano Gas Natural

SPECIFICATIONS · CARACTERÍSTICAS	Fusion 300 LITE	Fusion 400 LITE
Dimensions Medidas	W 64.4 x D 66.6 x H 78.3 cm	W 82.4 x D 66.6 x H 78.3 cm
Cooking Surface Dimension Superficie de Cocción	2.670 cm² 58×46 cm	3.540 cm² 77×46 cm
Cut-out Dimensions Dimensiones del Hueco para Encastrar	W 57 x D 54 x H 21 cm	W 78 x D 54 x H 21 cm
Capacity Capacidad	Suitable for 5-10 people Recomendada para 5-10 personas	Suitable for 10-15 people Recomendada para 10-15 personas
No of Burners / Power Nº de Quemadores / Potencia	3 / 3.81 kW	4 / 3.81 kW
Power Potencia	11.43 kW	15.24 kW
Weight Peso	53.8 Kg	63.7 Kg

Charcoal Grill Ember 800

Built-In and Portable · Encastrada y Portátil

Ref BCG0001



SPECIFICATIONS · CARACTERÍSTICAS

Dimensions Medidas	W 82.4 x D 70.8 x H 78.3 cm
Grates Material Material de la Rejilla	304 Stainless Steel Acero Inoxidable 304
Grates Thickness Espesor de la Rejilla	10.0 mm
Cooking Surface Dimension Superficie de Cocción	3.540 cm ² 77×46 cm
Cut-out Dimensions Dimensiones del Hueco para Encastrar	W 78 x D 54 x H 21 cm
Capacity Capacidad	Suitable for 10-15 people Recomendada para 10-15 personas
Control Panel Material Material del Panel de Control	304 Stainless Steel Acero Inoxidable 304
Grill Hood Material Material de la Tapa del Grill	304 Stainless Steel Acero Inoxidable 304
Chassis Material Material del Chasis	304 Stainless Steel Acero Inoxidable 304
Weight Peso	53.2 Kg



Kalentia & Gelantia



Capitano Pizza Oven 60

Ref BGG0017



SPECIFICATIONS · CARACTERÍSTICAS

External Dimensions · Dimensiones Exteriores	W 75.2 x D 56.5 x H (48) 105.4 cm
Gas Type · Tipo de Gas	Butane and Propane Natural Gas · Butano y Propano Gas Natural
Cooking Chamber Size · Dimensiones de la Cámara de Cocción	W 61 x D 40.5 x H 21 cm
Oven Mouth Size · Dimensiones de la Boca del Horno	W 42 x H 14 cm
Max Temperature Rating · Temperatura Máxima	482°C / 900°F
Pizza Capacity · Capacidad para Pizzas	Two 25 cm Pizzas One 30 cm Pizza Dos pizzas de 25 cm Una pizza de 30 cm
Power · Potencia	9.0 kW
Chimney Flue Ø · Ø Chimenea	120 mm
Weight · Peso	55 Kg

Bison Kamado 23

Ref BCG0002



SPECIFICATIONS · CARACTERÍSTICAS

Total Dimensions · Dimensiones Totales	Ø 58 cm H 83.4 cm
Material · Material	Ceramic · Cerámica
Grates Material · Material de la Rejilla	304 Stainless Steel · Acero Inoxidable 304
Grates Thickness · Espesor de la Rejilla	7.0 mm
Fire Box Material · Material de la Cámara de Combustión	Cordierite Ceramic · Cerámica de Cordierita
Charcoal Basket Material · Material de la Cesta para Carbón	304 Stainless Steel · Acero Inoxidable 304
Handle Material · Material del Asa	Bamboo · Bambú
Lock Material · Material del Cierre de Seguridad	304 Stainless Steel · Acero Inoxidable 304
Gasket · Material de la Junta	Fiberglass · Fibra de Vidrio
Hinge · Bisagra	Lift-Assist Hinge · Bisagra con Apertura Asistida
Top Cap Material · Material del Tiro Superior	Cast Iron · Hierro Fundido
Half-Moon Pizza Stones · Piedra para Pizzas en Media Luna	2 pcs, Ceramic · 2 piezas, Cerámica
Pizza Stone Thickness · Espesor de la Piedra para Pizzas	18.0 mm
Dampers Material · Material del Registro	304 Stainless Steel · Acero Inoxidable 304
Fuel Type · Tipo de Combustible	Charcoal · Carbón
Weight · Peso	102 Kg

Countertop Side Burners

Built-In · Encastrado

Ref BGG0019



SPECIFICATIONS · CARACTERÍSTICAS

Grates Material · Material de la Rejilla	Cast Iron · Hierro Fundido
Gas Type · Tipo de Gas	Butane and Propane Natural Gas · Butano y Propano Gas Natural
Medium Burner Power · Potencia del Quemador Medio	3.0 kW
Medium Burner Diameter · Diámetro del Quemador Medio	Ø180 mm
Wok/Simmer Burner Power Potencia del Quemador Wok/Fuego Lento	5.0 kW
Wok/Simmer Burner Diameter Diámetro del Quemador Wok/Fuego Lento	Ø240 mm
Ignition Type · Tipo de Encendido	Continuous Spark · Piezoeléctricos Automáticos
Weight · Peso	15 Kg
Countertop not included · Encimera no incluida	

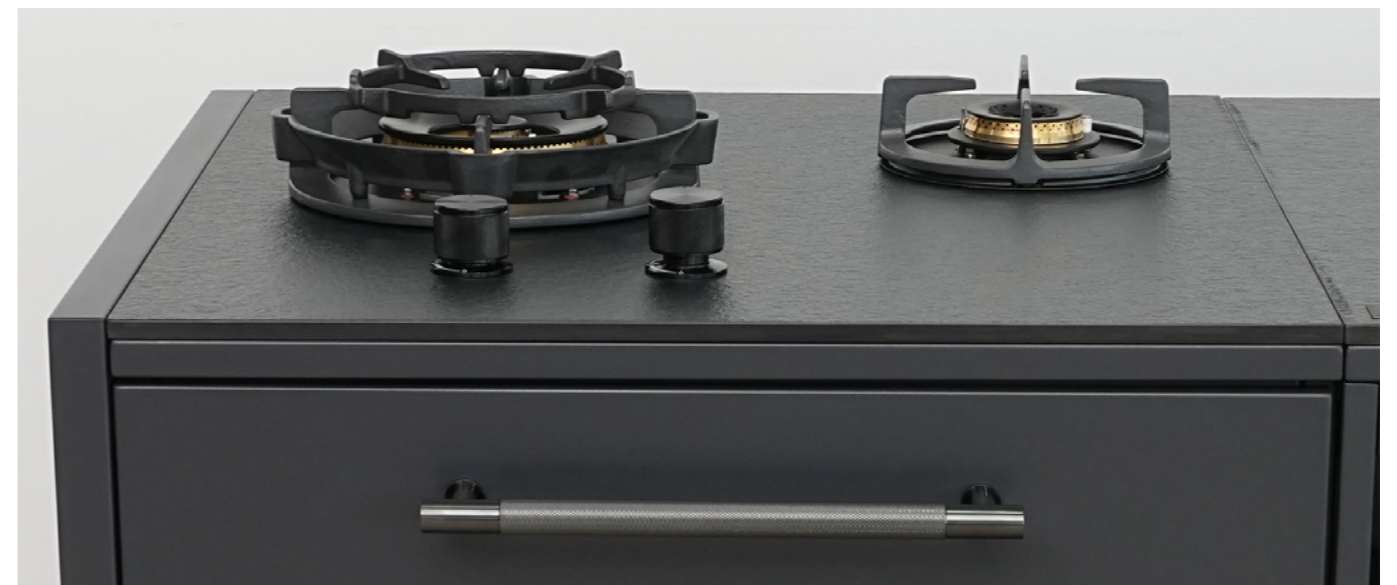

Outdoor Fridge SC-128F

Ref BGSC0024



SPECIFICATIONS · CARACTERÍSTICAS

Dimensions · Medidas	W 60 x D 50 x H 84 cm
Climate Class · Clase Climática	N-ST
Capacity · Capacidad	128L
Door · Puerta	Self closing premium triple layer anti-UV frameless full-glass door Puerta con cierre automático de vidrio premium de triple capa anti UV sin marco
Temperature Range · Rango Temperatura	2°C~10°C
Refrigerant · Refrigerante	R600a
Interior Light · Iluminación Interior	LED

Outdoor Fridge SC-60F

Ref BGSC0151



SPECIFICATIONS · CARACTERÍSTICAS

Dimensions · Medidas	W 43 x D 50 x H 69 cm
Climate Class · Clase Climática	N-ST
Capacity · Capacidad	60L
Door · Puerta	Self closing premium triple layer anti-UV frameless full-glass door Puerta con cierre automático de vidrio premium de triple capa anti UV sin marco
Temperature Range · Rango Temperatura	2°C~10°C
Refrigerant · Refrigerante	R600a
Interior Light · Iluminación Interior	LED

L Class Original 20

Countertop, Built-In and Portable
Sobre Encimera, Encastrada y Portátil

Ref BGG0003



L Class Original 30

Countertop, Built-In and Portable
Sobre Encimera, Encastrada y Portátil

Ref BGG0002



SPECIFICATIONS · CARACTERÍSTICAS	L Class Original 20 & L Class Original 30
Cooking Plate Material Material de la Placa	Premium Enamel Cast Iron Hierro Fundido Esmaltado Premium
Plate Thickness Espesor de la Placa	8.0 mm
Chassis Material Material del Chasis	304 Stainless Steel Acero Inoxidable 304
Burner Material Material de los Quemadores	Stainless Steel Acero Inoxidable
Configurations Configuraciones	Built-in Countertop Freestanding Encastre Sobre Encimera Carro
Gas Type Tipo de Gas	Butane and Propane Natural Gas Butano y Propano Gas Natural
Ignition Type Tipo de Encendido	Continuous Spark Piezoeléctricos Automáticos
Knobs Mandos de Control	LED-lit, Orange White Iluminación LED, Naranja Blanco

SPECIFICATIONS · CARACTERÍSTICAS	L Class Original 20	L Class Original 30
Dimensions Medidas	W 50.6 x D 60.9 x H 33 cm	W 81.3 x D 60.9 x H 33 cm
Cooking Surface Dimension Superficie de Cocción	2.160 cm² 48x45 cm	3.300 cm² 74x45 cm
Cut-out Dimensions Dimensiones del Hueco para Encastrar	W56 x D50 x H21 cm	W82 x D50 x H21 cm
Capacity Capacidad	Suitable for 12-16 people Recomendada para 12-16 personas	Suitable for 15-20 people Recomendada para 15-20 personas
No of Burners / Power Nº de Quemadores / Potencia	2 / 3.2 kW	3 / 3.2 kW
Power Potencia	6.4 kW	9.6 kW
Weight Peso	33.5 kg	43 kg

L Class Matte 20

Countertop, Built-In and Portable
Sobre Encimera, Encastrada y Portátil

Ref BGG0009



L Class Matte 30

Countertop, Built-In and Portable
Sobre Encimera, Encastrada y Portátil

Ref BGG0008



SPECIFICATIONS · CARACTERÍSTICAS	L Class Matte 20 & L Class Matte 30
Cooking Plate Material Material de la Placa	Premium Enamel Cast Iron Hierro Fundido Esmaltado Premium
Plate Thickness Espesor de la Placa	8.0 mm
Chassis Material Material del Chasis	Ultra durable powder coated stainless steel Acero inoxidable con recubrimiento en polvo ultra duradero
Burner Material Material de los Quemadores	Stainless Steel Acero Inoxidable
Configurations Configuraciones	Built-in Countertop Freestanding Encastre Sobre Encimera Carro
Gas Type Tipo de Gas	Butane and Propane Natural Gas Butano y Propano Gas Natural
Ignition Type Tipo de Encendido	Continuous Spark Piezoeléctricos Automáticos
Knobs Mandos de Control	LED-lit, Orange White Iluminación LED, Naranja Blanco

SPECIFICATIONS · CARACTERÍSTICAS	L Class Matte 20	L Class Matte 30
Dimensions Medidas	W 50.6 x D 60.9 x H 33 cm	W 81.3 x D 60.9 x H 33 cm
Cooking Surface Dimension Superficie de Cocción	2.160 cm² 48x45 cm	3.300 cm² 74x45 cm
Cut-out Dimensions Dimensiones del Hueco para Encastrar	W56 x D50 x H21 cm	W82 x D50 x H21 cm
Capacity Capacidad	Suitable for 12-16 people Recomendada para 12-16 personas	Suitable for 15-20 people Recomendada para 15-20 personas
No of Burners / Power Nº de Quemadores / Potencia	2 / 3.2 kW	3 / 3.2 kW
Power Potencia	6.4 kW	9.6 kW
Weight Peso	33.5 kg	43 kg



L Class Inox 20

Countertop, Built-In and Portable
Sobre Encimera, Encastrada y Portátil

Ref BGG0006



SPECIFICATIONS · CARACTERÍSTICAS

Dimensions · Medidas	W 50.6 x D 60.9 x H 29.2 cm
Cooking Plate Material · Material de la Placa	304 Stainless Steel · Acero Inoxidable 304
Plate Thickness · Espesor de la Placa	10.0 mm
Cooking Surface Dimension · Superficie de Cocción	2.300 cm ² 50×46 cm
Cut-out Dimensions · Dimensiones del Hueco para Encastrar	W 56 x D 50 x H 21 cm
Capacity · Capacidad	Suitable for 12-16 people · Recomendada para 12-16 personas
Chassis Material · Material del Chasis	304 Stainless Steel · Acero Inoxidable 304
Burner Material · Material de los Quemadores	Stainless Steel · Acero Inoxidable
Configurations · Configuraciones	Built-in Countertop Freestanding · Encastre Sobre Encimera Carro
Gas Type · Tipo de Gas	Butane and Propane Natural Gas · Butano y Propano Gas Natural
No of Burners / Power · Nº de Quemadores / Potencia	2 / 3.2 kW
Power · Potencia	6.4 kW
Ignition Type · Tipo de Encendido	Continuous Spark · Piezoeléctricos Automáticos
Knobs · Mandos de Control	LED-lit, Orange White · Iluminación LED, Naranja Blanco
Weight · Peso	38.5 kg

L Class Inox 30

Countertop, Built-In and Portable
Sobre Encimera, Encastrada y Portátil

Ref BGG0005



SPECIFICATIONS · CARACTERÍSTICAS

Dimensions · Medidas	W 81.3 x D 60.9 x H 29.2 cm
Cooking Plate Material · Material de la Placa	304 Stainless Steel · Acero Inoxidable 304
Plate Thickness · Espesor de la Placa	10.0 mm
Cooking Surface Dimension · Superficie de Cocción	3.496 cm ² 76×46 cm
Cut-out Dimensions · Dimensiones del Hueco para Encastrar	W 82 x D 50 x H 21 cm
Capacity · Capacidad	Suitable for 15-20 people · Recomendada para 15-20 personas
Chassis Material · Material del Chasis	304 Stainless Steel · Acero Inoxidable 304
Burner Material · Material de los Quemadores	Stainless Steel · Acero Inoxidable
Configurations · Configuraciones	Built-in Countertop Freestanding · Encastre Sobre Encimera Carro
Gas Type · Tipo de Gas	Butane and Propane Natural Gas · Butano y Propano Gas Natural
No of Burners / Power · Nº de Quemadores / Potencia	3 / 3.2 kW
Power · Potencia	9.6 kW
Ignition Type · Tipo de Encendido	Continuous Spark · Piezoeléctricos Automáticos
Knobs · Mandos de Control	LED-lit, Orange White · Iluminación LED, Naranja Blanco
Weight · Peso	51 kg

L Class Inox 40

Countertop, Built-In and Portable
Sobre Encimera, Encastrada y Portátil

Ref BGG0004



SPECIFICATIONS · CARACTERÍSTICAS

Dimensions · Medidas	W 101.6 x D 60.9 x H 29.2 cm
Cooking Plate Material · Material de la Placa	304 Stainless Steel · Acero Inoxidable 304
Plate Thickness · Espesor de la Placa	10.0 mm
Cooking Surface Dimension · Superficie de Cocción	4.416 cm ² 96×46 cm
Cut-out Dimensions · Dimensiones del Hueco para Encastrar	W 102 x D50 x H 21 cm
Capacity · Capacidad	Suitable for 25-30 people · Recomendada para 25-30 personas
Chassis Material · Material del Chasis	304 Stainless Steel · Acero Inoxidable 304
Burner Material · Material de los Quemadores	Stainless Steel · Acero Inoxidable
Configurations · Configuraciones	Built-in Countertop Freestanding · Encastre Sobre Encimera Carro
Gas Type · Tipo de Gas	Butane and Propane Natural Gas · Butano y Propano Gas Natural
No of Burners / Power · Nº de Quemadores / Potencia	4 / 3.2 kW
Power · Potencia	12.8 kW
Ignition Type · Tipo de Encendido	Continuous Spark · Piezoeléctricos Automáticos
Knobs · Mandos de Control	LED-lit, Orange White · Iluminación LED, Naranja Blanco
Weight · Peso	62 kg

L Class Inox Series



SPECIFICATIONS · CARACTERÍSTICAS	L Class Inox 20	L Class Inox 30	L Class Inox 40
Dimensions Medidas	W 50.6 x D 60.9 x H 29.2 cm	W 81.3 x D 60.9 x H 29.2 cm	W 101.6 x D 60.9 x H 29.2 cm
Cooking Surface Dimension Superficie de Cocción	2.300 cm ² 50×46 cm	3.496 cm ² 76×46 cm	4.416 cm ² 96×46 cm
Cut-out Dimensions Dimensiones del Hueco para Encastrar	W 56 x D 50 x H 21 cm	W 82 x D 50 x H 21 cm	W 102 x D50 x H 21 cm
Capacity Capacidad	Suitable for 12-16 people Recomendada para 12-16 personas	Suitable for 15-20 people Recomendada para 15-20 personas	Suitable for 25-30 people Recomendada para 25-30 personas
No of Burners / Power Nº de Quemadores / Potencia	2 / 3.2 kW	3 / 3.2 kW	4 / 3.2 kW
Power Potencia	6.4 kW	9.6 kW	12.8 kW
Weight Peso	38.5 kg	51 kg	62 kg
Cooking Plate Material Material de la Placa	304 Stainless Steel Acero Inoxidable 304		
Plate Thickness Espesor de la Placa	10.0 mm		
Chassis Material Material del Chasis	304 Stainless Steel Acero Inoxidable 304		
Burner Material Material de los Quemadores	Stainless Steel Acero Inoxidable		
Configurations Configuraciones	Built-in Countertop Freestanding Encastre Sobre Encimera Carro		
Gas Type Tipo de Gas	Butane and Propane Natural Gas Butano y Propano Gas Natural		
Ignition Type Tipo de Encendido	Continuous Spark Piezoeléctricos Automáticos		
Knobs Mandos de Control	LED-lit, Orange White Iluminación LED, Naranja Blanco		
Optional Lid Tapa Abisagrada Opcional	Lid 20	Lid 30	Lid 40
Optional Cover Tapa Simple Opcional	Inox Cover 20 Matte Cover 20	Inox Cover30 Matte Cover 30	Inox Cover 40 Matte Cover 40
Optional Cart Carro Opcional	Inox Cart 20 Matte Cart 20	Inox Cart 30 Matte Cart 30	Inox Cart 40 Matte Cart 40

L Class Special 20

Countertop, Built-In and Portable
Sobre Encimera, Encastrada y Portátil

Ref BGG0012



SPECIFICATIONS · CARACTERÍSTICAS

Dimensions · Medidas	W 50.6 x D 60.9 x H 29.2 cm
Cooking Plate Material · Material de la Placa	304 Stainless Steel · Acero Inoxidable 304
Plate Thickness · Espesor de la Placa	10.0 mm
Cooking Surface Dimension · Superficie de Cocción	2.300 cm ² 50×46 cm
Cut-out Dimensions · Dimensiones del Hueco para Encastrar	W 56 x D 50 x H 21 cm
Capacity · Capacidad	Suitable for 12-16 people · Recomendada para 12-16 personas
Chassis Material · Material del Chasis	Ultra durable powder coated galvanized steel Acero galvanizado con recubrimiento en polvo ultra duradero
Burner Material · Material de los Quemadores	Stainless Steel · Acero Inoxidable
Configurations · Configuraciones	Built-in Countertop Freestanding · Encastre Sobre Encimera Carro
Gas Type · Tipo de Gas	Butane and Propane Natural Gas · Butano y Propano Gas Natural
No of Burners / Power · Nº de Quemadores / Potencia	2 / 3.2 kW
Power · Potencia	6.4 kW
Ignition Type · Tipo de Encendido	Continuous Spark · Piezoeléctricos Automáticos
Knobs · Mandos de Control	LED-lit, Orange White · Iluminación LED, Naranja Blanco
Weight · Peso	38.5 kg

L Class Special 30

Countertop, Built-In and Portable
Sobre Encimera, Encastrada y Portátil

Ref BGG0011



SPECIFICATIONS · CARACTERÍSTICAS

Dimensions · Medidas	W 81.3 x D 60.9 x H 29.2 cm
Cooking Plate Material · Material de la Placa	304 Stainless Steel · Acero Inoxidable 304
Plate Thickness · Espesor de la Placa	10.0 mm
Cooking Surface Dimension · Superficie de Cocción	3.496 cm ² 76×46 cm
Cut-out Dimensions · Dimensiones del Hueco para Encastrar	W 82 x D 50 x H 21 cm
Capacity · Capacidad	Suitable for 15-20 people · Recomendada para 15-20 personas
Chassis Material · Material del Chasis	Ultra durable powder coated galvanized steel Acero galvanizado con recubrimiento en polvo ultra duradero
Burner Material · Material de los Quemadores	Stainless Steel · Acero Inoxidable
Configurations · Configuraciones	Built-in Countertop Freestanding · Encastre Sobre Encimera Carro
Gas Type · Tipo de Gas	Butane and Propane Natural Gas · Butano y Propano Gas Natural
No of Burners / Power · Nº de Quemadores / Potencia	3 / 3.2 kW
Power · Potencia	9.6 kW
Ignition Type · Tipo de Encendido	Continuous Spark · Piezoeléctricos Automáticos
Knobs · Mandos de Control	LED-lit, Orange White · Iluminación LED, Naranja Blanco
Weight · Peso	51 kg

L Class Special 40

Countertop, Built-In and Portable
Sobre Encimera, Encastrada y Portátil

Ref BGG0010



SPECIFICATIONS · CARACTERÍSTICAS

Dimensions · Medidas	W 101.6 x D 60.9 x H 29.2 cm
Cooking Plate Material · Material de la Placa	304 Stainless Steel · Acero Inoxidable 304
Plate Thickness · Espesor de la Placa	10.0 mm
Cooking Surface Dimension · Superficie de Cocción	4.416 cm ² 96×46 cm
Cut-out Dimensions · Dimensiones del Hueco para Encastrar	W 102 x D50 x H 21 cm
Capacity · Capacidad	Suitable for 25-30 people · Recomendada para 25-30 personas
Chassis Material · Material del Chasis	Ultra durable powder coated stainless steel Acero inoxidable con recubrimiento en polvo ultra duradero
Burner Material · Material de los Quemadores	Stainless Steel · Acero Inoxidable
Configurations · Configuraciones	Built-in Countertop Freestanding · Encastre Sobre Encimera Carro
Gas Type · Tipo de Gas	Butane and Propane Natural Gas · Butano y Propano Gas Natural
No of Burners / Power · Nº de Quemadores / Potencia	4 / 3.2 kW
Power · Potencia	12.8 kW
Ignition Type · Tipo de Encendido	Continuous Spark · Piezoeléctricos Automáticos
Knobs · Mandos de Control	LED-lit, Orange White · Iluminación LED, Naranja Blanco
Weight · Peso	62 kg

L Class Special Series



SPECIFICATIONS · CARACTERÍSTICAS	L Class Inox 20	L Class Inox 30	L Class Inox 40
Dimensions Medidas	W 50.6 x D 60.9 x H 29.2 cm	W 81.3 x D 60.9 x H 29.2 cm	W 101.6 x D 60.9 x H 29.2 cm
Cooking Surface Dimension Superficie de Cocción	2.300 cm ² 50×46 cm	3.496 cm ² 76×46 cm	4.416 cm ² 96×46 cm
Cut-out Dimensions Dimensiones del Hueco para Encastrar	W 56 x D 50 x H 21 cm	W 82 x D 50 x H 21 cm	W 102 x D50 x H 21 cm
Capacity Capacidad	Suitable for 12-16 people Recomendada para 12-16 personas	Suitable for 15-20 people Recomendada para 15-20 personas	Suitable for 25-30 people Recomendada para 25-30 personas
No of Burners / Power Nº de Quemadores / Potencia	2 / 3.2 kW	3 / 3.2 kW	4 / 3.2 kW
Power Potencia	6.4 kW	9.6 kW	12.8 kW
Weight Peso	38.5 kg	51 kg	62 kg
Cooking Plate Material Material de la Placa	304 Stainless Steel Acero Inoxidable 304		
Plate Thickness Espesor de la Placa	10.0 mm		
Chassis Material Material del Chasis	Ultra durable powder coated stainless steel Acero inoxidable con recubrimiento en polvo ultra duradero		
Burner Material Material de los Quemadores	Stainless Steel Acero Inoxidable		
Configurations Configuraciones	Built-in Countertop Freestanding Encastre Sobre Encimera Carro		
Gas Type Tipo de Gas	Butane and Propane Natural Gas Butano y Propano Gas Natural		
Ignition Type Tipo de Encendido	Continuous Spark Piezoeléctricos Automáticos		
Knobs Mandos de Control	LED-lit, Orange White Iluminación LED, Naranja Blanco		
Optional Cover Tapa Simple Opcional	Inox Cover 20 Matte Cover 20	Inox Cover30 Matte Cover 30	Inox Cover 40 Matte Cover 40
Optional Cart Carro Opcional	Inox Cart 20 Matte Cart 20	Inox Cart 30 Matte Cart 30	Inox Cart 40 Matte Cart 40

Accessories

Accesorios



Walls

Material · Material:
Ultra durable powder coated stainless steel (Qualisteelcoat) and bamboo wood
Acero inoxidable con recubrimiento en polvo ultra duradero (Qualisteelcoat) y madera de bambú

Standard · Estándar

 **Bamboo**
Bambú

Or Customise Top Finish
O Personaliza tu Estante

 **Nero Zimbabwe**

 **Pietra Di Luna**

 **Iron Frost**

 **Summer Dala**

 **Basalt Black**

 **Iron Corten**

 **Pietra Di Osso**

 **Barro**

Wall Colour Choice
Elección de Color de Wall

 **Anthracite Grey**
Gris Antracita

 **Pearl White**
Blanco Perla



Wall 50

Ref BKC0041

Specific to · Especifico para:
CT 50 Ice Maker



Wall 60

Ref BKC0009

Specific to · Especifico para:
CT 60 / Fridge / Sink / Worktop



Wall 80

Ref BKC0010

Specific to · Especifico para:
KC 80



Wall 90

Ref BKC0011

Specific to · Especifico para:
CT 90 / Open / Sink / Corner



Wall 100

Ref BKC0012

Specific to · Especifico para:
KC 100



Wall 120

Ref BKC0013

Specific to · Especifico para:
KC 120



Wall Corner

Ref BKC0031

Specific to · Especifico para:
CT 90 Corner / Ice Cube Bin
Corner / Plant Corner

Standing Bars

Material · Material:
Ultra durable powder coated stainless steel (Qualisteelcoat) and bamboo wood
Acero inoxidable con recubrimiento en polvo ultra duradero (Qualisteelcoat) y madera de bambú

Standard · Estándar

 **Bamboo**
Bambú

Or Choose Bar Colour
O Elige de Color de Bar

 **Anthracite Grey**
Gris Antracita

 **Pearl White**
Blanco Perla

Angle Colour Choice
Elección de Color del Ángulo

 **Anthracite Grey**
Gris Antracita

 **Pearl White**
Blanco Perla

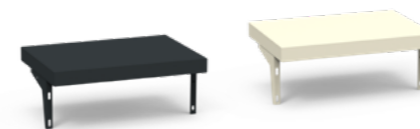

Standing Bar 50

Ref BKC0042

Specific to · Especifico para:
CT 50 Ice Maker



Standing Bar 60

Ref BKC0014

Specific to · Especifico para:
CT 60 / Fridge / Sink / Worktop



Standing Bar 80

Ref BKC0015

Specific to · Especifico para:
KC 80



Standing Bar 90

Ref BKC0016

Specific to · Especifico para:
CT 90 / Open / Sink / Corner



Standing Bar 100

Ref BKC0017

Specific to · Especifico para:
KC 100



Standing Bar 120

Ref BKC0018

Specific to · Especifico para:
KC 120

End Panels

Ref BKC0019

Material - Material:
Ultra durable powder coated stainless steel (Qualisteelcoat)
 Acero inoxidable con recubrimiento en polvo ultra duradero (Qualisteelcoat)

Panel Colour Choice
 Elección de Color de Panel:

- Anthracite Grey**
Gris Antracita
- Pearl White**
Blanco Perla



LITE Soft Covers

Fundas LITE



Soft Cover LITE Series 400

Ref BGA0058

Specific to · Especifico para:
 LITE Series 400

Soft Cover LITE Series 300

Ref BGA0057

Specific to · Especifico para:
 LITE Series 300

Kamado End Panel

Ref BKC0022

Material - Material:
Ultra durable powder coated stainless steel (Qualisteelcoat)
 Acero inoxidable con recubrimiento en polvo ultra duradero (Qualisteelcoat)

Panel Colour Choice
 Elección de Color de Panel:

- Anthracite Grey**
Gris Antracita
- Pearl White**
Blanco Perla



Custom Modula Soft Covers

Fundas a Medida para Modula



Cart Grill 400 S

Ref BGC0007



Specific to Específico para	Fusion RS Fusion RM Ember 800
Weight Peso	40.8 kg
Body Material Material	304 Stainless steel Acero inoxidable 304
Folding Trays Bandejas Abatibles	✓
Interior Gas Bottle Holder Portabombona Interior	✓
Optional Opcional	Cart Soft Cover

Grill not included · Barbacoa no incluida

Cart Grill 400 M

Ref BGC0009



Specific to Específico para	Fusion RS Fusion RM
Weight Peso	40.8 kg
Body Material Material	Ultra durable powder coated stainless steel (Qualisteelcoat) Acero inoxidable con recubrimiento en polvo ultra duradero (Qualisteelcoat)
Folding Trays Bandejas Abatibles	✓
Interior Gas Bottle Holder Portabombona Interior	✓
Optional Opcional	Cart Soft Cover

Grill not included · Barbacoa no incluida

Cart Grill 500 S

Ref BGC0008



Specific to Específico para	Fusion RS Fusion RM
Weight Peso	45.3 kg
Body Material Material	304 Stainless steel Acero inoxidable 304
Folding Trays Bandejas Abatibles	✓
Interior Gas Bottle Holder Portabombona Interior	✓
Optional Opcional	Cart Soft Cover

Grill not included · Barbacoa no incluida

Cart Grill 500 M

Ref BGC0010



Specific to Específico para	Fusion RS Fusion RM
Weight Peso	45.3 kg
Body Material Material	Ultra durable powder coated stainless steel (Qualisteelcoat) Acero inoxidable con recubrimiento en polvo ultra duradero (Qualisteelcoat)
Folding Trays Bandejas Abatibles	✓
Interior Gas Bottle Holder Portabombona Interior	✓
Optional Opcional	Cart Soft Cover

Grill not included · Barbacoa no incluida

Plancha 200S

Ref BGA0028



Specific to · Especifico para	Fusion 400 RS Fusion 400 RM Ember 800 Fusion 500 RS Fusion 500 RM
Dimensions · Dimensiones	W 369 x D 452 x H 89 mm
Weight · Peso	9.5 Kg
Material · Material	304 Stainless steel Acero inoxidable 304

Reversible 40 Plancha

Ref BGA0052

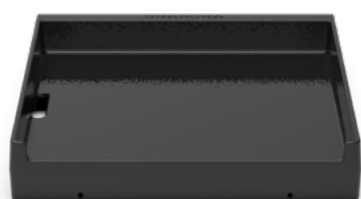

Specific to · Especifico para	Fusion 400 RS Fusion 400 RM Ember 800 Fusion 500 RS Fusion 500 RM
Dimensions · Dimensiones	W 410 x D 452 x H 60 mm
Weight · Peso	15 Kg
Material · Material	Premium Enamel Cast Iron Hierro Fundido Esmaltado Premium

Reversible 60 Plancha

Ref BGA0053

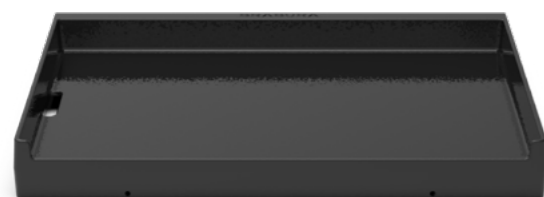

Specific to · Especifico para	Fusion 400 RS Fusion 400 RM Ember 800 Fusion 500 RS Fusion 500 RM
Dimensions · Dimensiones	W 600 x D 452 x H 60 mm
Weight · Peso	20 Kg
Material · Material	Premium Enamel Cast Iron Hierro Fundido Esmaltado Premium

Pizza Q

Ref BGA0054

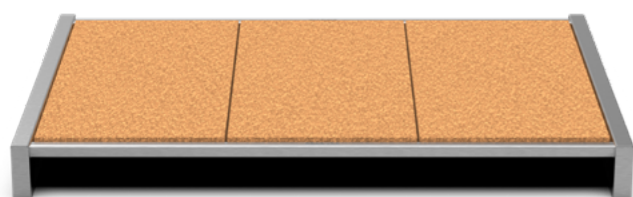

Specific to · Especifico para	Fusion 400 RS Fusion 400 RM Ember 800 Fusion 500 RS Fusion 500 RM
Dimensions · Dimensiones	W 650 x D 450 x H 55 mm
Weight · Peso	20 Kg
Chassis Material Material del Chasis	304 Stainless steel Acero inoxidable 304
Stone Material Material de la Piedra	Firebrick Ladrillo refractario

Rotisserie Kit 400

Ref BGA0025



Specific to Especifico para	Fusion 400 RS Fusion 400 RM Ember 800
Material Material	Stainless steel (Includes motor, spit rod, 2 forks and counter balance) Acero inoxidable (Incluye motor, asador, 2 tenedores y contrapeso)

Rotisserie Kit 500

Ref BGA0026



Specific to Especifico para	Fusion 500 RS Fusion 500 RM
Material Material	Stainless steel (Includes motor, spit rod, 2 forks and counter balance) Acero inoxidable (Incluye motor, asador, 2 tenedores y contrapeso)

Sear Burner

Ref BGA0027

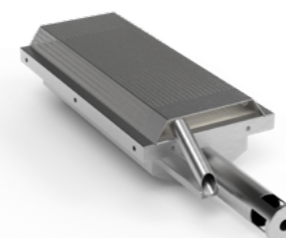

Specific to Especifico para	Fusion 400 RS Fusion 400 RM Ember 800 Fusion 500 RS Fusion 500 RM
Material Material	Stainless Steel Acero inoxidable

Laser Cut Grate

Ref BGA0030

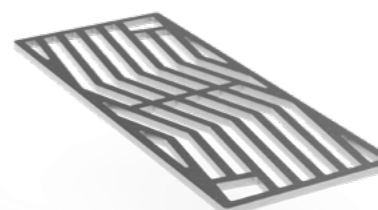

Specific to Especifico para	Fusion 400 RS Fusion 400 RM Ember 800 Fusion 500 RS Fusion 500 RM
Dimensions Dimensiones	W 187 x D 457 x H 8 mm
Weight Peso	2.9 Kg
Material Material	304 Stainless steel Acero inoxidable 304

Liner 400 S

Ref BGL0004

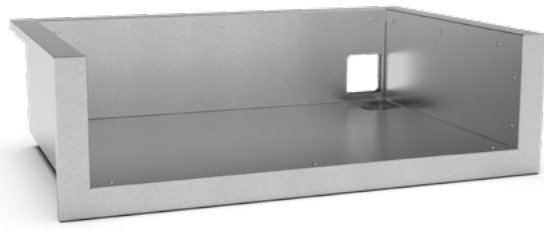

Specific to Específico para	Fusion 400 RS Fusion 400 RM Ember 800
Cut-out Dimensions Dimensiones del Hueco para Encastrar	W 83 x D 54.6 x H 21.7 cm
Weight Peso	20 Kg
Material Material	304 Stainless steel Acero inoxidable 304

Liner 500 S

Ref BGL0005



Specific to Específico para	Fusion 500 RS Fusion 500 RM
Cut-out Dimensions Dimensiones del Hueco para Encastrar	W 101.4 x D 54.6 x H 21.7 cm
Weight Peso	22 Kg
Material Material	304 Stainless steel Acero inoxidable 304

Cover Countertop Side Burners

Ref BGLD0014



Specific to Específico para	Countertop Side Burners
Weight Peso	7 Kg
Body Material Material	Ultra durable powder coated stainless steel (Qualisteelcoat) Acero galvanizado con recubrimiento en polvo ultra duradero (Qualisteelcoat)
Handle Material Material del Tirador	304 Stainless steel Acero inoxidable 304

Soft Covers · Fundas

Built-In · Encastrada



Built-In Soft Cover 300

Ref BGA0055

Specific to · Especifico para:
Fusion 300 LITE

Built-In Soft Cover 400

Ref BGA0037

Specific to · Especifico para:
Fusion 400 RS | Fusion 400 RM

Built-In Soft Cover 500

Ref BGA0031

Specific to · Especifico para:
Fusion 400 RS | Fusion 400 RM

Built-In Soft Cover Ember

Ref BGA0032

Specific to · Especifico para:
Ember 800

On-cart · Sobre carro



Grill Cart Soft Cover 400

Ref BGA0033

Specific to · Especifico para:
Fusion 400 RS / RM | Ember 800
+ Grill Cart 400 S / M

Grill Cart Soft Cover 500

Ref BGA0034

Specific to · Especifico para:
Fusion 500 RS / RM
+ Grill Cart 500 S / M

Inox Cart 20

Ref BGC0003



Specific to Específico para	L Class Original 20 L Class Matte 20 L Class Inox 20 L Class Special 20
Weight · Peso	33.5 kg
Body Material Material	304 Stainless Steel Acero Inoxidable 304
Folding Trays Bandejas Abatibles	✓
Interior Gas Bottle Holder Portabombona Interior	✓
Optional · Opcional	Cart Soft Cover 20
Plancha not included · Plancha no incluida	

Matte Cart 20

Ref BGC0006



Specific to Específico para	L Class Original 20 L Class Matte 20 L Class Inox 20 L Class Special 20
Weight · Peso	33.5 kg
Body Material Material	Ultra durable powder coated stainless steel (Qualisteelcoat) Acero inoxidable con recubrimiento en polvo ultra duradero (Qualisteelcoat)
Folding Trays Bandejas Abatibles	✓
Interior Gas Bottle Holder Portabombona Interior	✓
Optional · Opcional	Cart Soft Cover 20
Plancha not included · Plancha no incluida	

Inox Cart 30

Ref BGC0002



Specific to Específico para	L Class Original 30 L Class Matte 30 L Class Inox 30 L Class Special 30
Weight · Peso	40.5 kg
Body Material Material	304 Stainless Steel Acero Inoxidable 304
Folding Trays Bandejas Abatibles	✓
Interior Gas Bottle Holder Portabombona Interior	✓
Optional Opcional	Cart Soft Cover 30
Plancha not included · Plancha no incluida	

Matte Cart 30

Ref BGC0005



Specific to Específico para	L Class Original 30 L Class Matte 30 L Class Inox 30 L Class Special 30
Weight · Peso	40.5 kg
Body Material Material	Ultra durable powder coated stainless steel (Qualisteelcoat) Acero inoxidable con recubrimiento en polvo ultra duradero (Qualisteelcoat)
Folding Trays Bandejas Abatibles	✓
Interior Gas Bottle Holder Portabombona Interior	✓
Optional · Opcional	Cart Soft Cover 20
Plancha not included · Plancha no incluida	

Inox Cart 40

Ref BGC0001



Specific to Específico para	L Class Inox 40 L Class Special 40
Weight · Peso	45.5 kg
Body Material Material	304 Stainless Steel Acero Inoxidable 304
Folding Trays Bandejas Abatibles	✓
Interior Gas Bottle Holder Portabombona Interior	✓
Optional Opcional	Cart Soft Cover 40
Plancha not included · Plancha no incluida	

Matte Cart 40

Ref BGC0004



Specific to Específico para	L Class Inox 40 L Class Special 40
Weight · Peso	45.5 kg
Body Material Material	Ultra durable powder coated stainless steel (Qualisteelcoat) Acero inoxidable con recubrimiento en polvo ultra duradero (Qualisteelcoat)
Folding Trays Bandejas Abatibles	✓
Interior Gas Bottle Holder Portabombona Interior	✓
Optional · Opcional	Cart Soft Cover 20
Plancha not included · Plancha no incluida	

Inox Cover 20

Ref BGLD0006

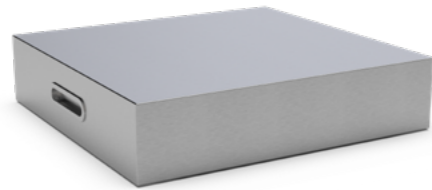

Specific to Específico para	L Class Original 20 L Class Matte 20 L Class Inox 20 L Class Special 20
Weight Peso	6.5 kg
Body Material Material	304 Stainless Steel Acero Inoxidable 304
Handle Material Material del Tirador	304 Stainless Steel Acero Inoxidable 304
Optional Opcional	Built-In Soft Cover 20 Countertop Soft Cover 20

Matte Cover 20

Ref BGLD0007



Specific to Específico para	L Class Original 20 L Class Matte 20 L Class Inox 20 L Class Special 20
Weight Peso	6.5 kg
Body Material Material	Ultra durable powder coated stainless steel (Qualisteelcoat) Acero inoxidable con recubrimiento en polvo ultra duradero (Qualisteelcoat)
Handle Material Material del Tirador	304 Stainless Steel Acero Inoxidable 304
Optional Opcional	Built-In Soft Cover 20 Countertop Soft Cover 20

Inox Cover 30

Ref BGLD0005

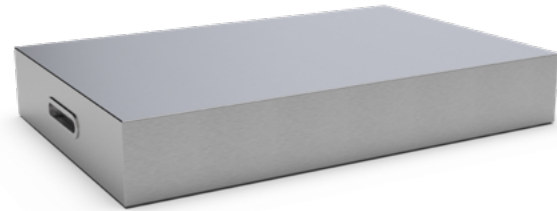

Specific to Específico para	L Class Original 30 L Class Matte 30 L Class Inox 30 L Class Special 30
Weight Peso	8.5 kg
Body Material Material	304 Stainless Steel Acero Inoxidable 304
Handle Material Material del Tirador	304 Stainless Steel Acero Inoxidable 304
Optional Opcional	Built-In Soft Cover 30 Countertop Soft Cover 30

Matte Cover 30

Ref BGLD0008



Specific to Específico para	L Class Original 30 L Class Matte 30 L Class Inox 30 L Class Special 30
Weight Peso	8.5 kg
Body Material Material	Ultra durable powder coated stainless steel (Qualisteelcoat) Acero inoxidable con recubrimiento en polvo ultra duradero (Qualisteelcoat)
Handle Material Material del Tirador	304 Stainless Steel Acero Inoxidable 304
Optional Opcional	Built-In Soft Cover 30 Countertop Soft Cover 30

Inox Cover 40

Ref BGLD0004

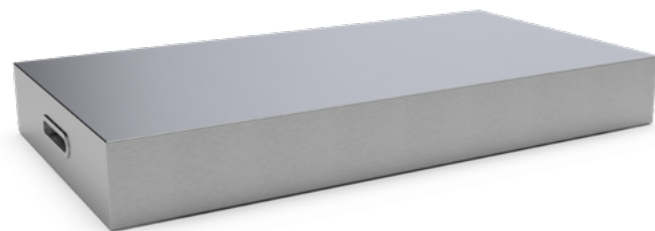

Specific to Específico para	L Class Inox 40 L Class Special 40
Weight Peso	10 kg
Body Material Material	304 Stainless Steel Acero Inoxidable 304
Handle Material Material del Tirador	304 Stainless Steel Acero Inoxidable 304
Optional Opcional	Built-In Soft Cover 40 Countertop Soft Cover 40

Matte Cover 40

Ref BGLD0009



Specific to Específico para	L Class Inox 40 L Class Special 40
Weight Peso	10 kg
Body Material Material	Ultra durable powder coated stainless steel (Qualisteelcoat) Acero inoxidable con recubrimiento en polvo ultra duradero (Qualisteelcoat)
Handle Material Material del Tirador	304 Stainless Steel Acero Inoxidable 304
Optional Opcional	Built-In Soft Cover 40 Countertop Soft Cover 40

Lid 20

Ref BGLD0003



Specific to Específico para	L Class Original 20 L Class Inox 20
Weight Peso	10.5 kg
Body Material Material	304 Stainless Steel Acero Inoxidable 304
Double Wall Insulated Material Material de la Doble Pared Aislante	304 Stainless Steel Acero Inoxidable 304
Handle Material Material del Tirador	304 Stainless Steel Acero Inoxidable 304
Optional Opcional	Built-In Soft Cover 20 Countertop Soft Cover 20 Inox Cart 20

Liner 20

Ref BGL0003

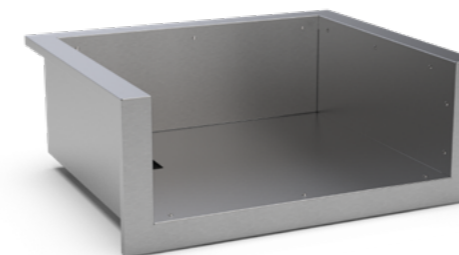

Specific to Específico para	L Class Original 20 L Class Matte 20 L Class Inox 20 L Class Special 20
Insulated Liner Cutout Dimensiones del Hueco para Encastre con el revestimiento aislante	W 60.9 x D 50.6 x H 21.7 cm
Weight Peso	15 kg
Body Material Material	304 Stainless Steel Acero Inoxidable 304
Double Wall Insulated Material Material de la Doble Pared Aislante	304 Stainless Steel Acero Inoxidable 304
Optional Opcional	Built-In Soft Cover

Lid 30

Ref BGLD0002

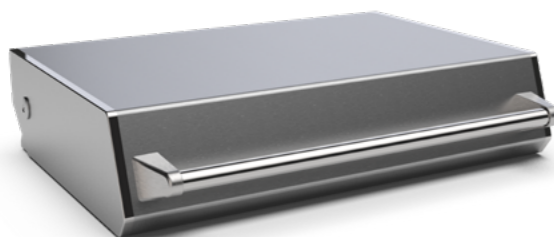

Specific to Específico para	L Class Original 30 L Class Inox 30
Weight Peso	13.5 kg
Body Material Material	304 Stainless Steel Acero Inoxidable 304
Double Wall Insulated Material Material de la Doble Pared Aislante	304 Stainless Steel Acero Inoxidable 304
Handle Material Material del Tirador	304 Stainless Steel Acero Inoxidable 304
Optional Opcional	Built-In Soft Cover 30 Countertop Soft Cover 30 Inox Cart 30

Liner 30

Ref BGL0002



Specific to Específico para	L Class Original 30 L Class Matte 30 L Class Inox 30 L Class Special 30
Insulated Liner Cutout Dimensiones del Hueco para Encastre con el revestimiento aislante	W 86.3 x D 50.6 x H 21.7 cm
Weight Peso	19.5 kg
Body Material Material	304 Stainless Steel Acero Inoxidable 304
Double Wall Insulated Material Material de la Doble Pared Aislante	304 Stainless Steel Acero Inoxidable 304
Optional Opcional	Built-In Soft Cover

Lid 40

Ref BGLD0001

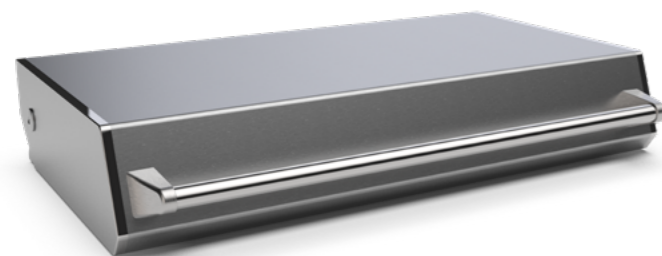

Specific to Específico para	L Class Inox 40
Weight Peso	16 kg
Body Material Material	304 Stainless Steel Acero Inoxidable 304
Double Wall Insulated Material Material de la Doble Pared Aislante	304 Stainless Steel Acero Inoxidable 304
Handle Material Material del Tirador	304 Stainless Steel Acero Inoxidable 304
Optional Opcional	Built-In Soft Cover 40 Countertop Soft Cover 40 Inox Cart 40

Liner 40

Ref BGL0001



Specific to Específico para	L Class Inox 40 L Class Special 40
Insulated Liner Cutout Dimensiones del Hueco para Encastre con el revestimiento aislante	W 106.6 x D 50.6 x H 21.7 cm
Weight Peso	21.5 kg
Body Material Material	304 Stainless Steel Acero Inoxidable 304
Double Wall Insulated Material Material de la Doble Pared Aislante	304 Stainless Steel Acero Inoxidable 304
Optional Opcional	Built-In Soft Cover

Basting Cover 20 S

Ref BGA0012



Dimensions
Dimensiones

ø 20 cm

Material
Material

Stainless steel
Acero inoxidable

Basting Cover 30 SG

Ref BGA0013



Dimensions
Dimensiones

ø 30 cm

Material
Material

Stainless steel
(and glass, BGA0013)
Acero inoxidable (y cristal, BGA0013)

Basting Cover 30 S

Ref BGA0014



Dimensions
Dimensiones

ø 30 cm

Material
Material

Stainless steel
Acero inoxidable

Spatula Kit

Ref BGA0024



Scraper and turner spatula
Espatula plana y acodada

Material
Material

Stainless steel
Acero inoxidable

Soft Covers · Fundas

Built-In · Encastrada



Built-In Soft Cover 20

Ref BGA0017

Specific to · Especifico para:
L Class 20 Original / Matte / Inox / Special

Built-In Soft Cover 30

Ref BGA0016

Specific to · Especifico para:
L Class 30 Original / Matte / Inox / Special

Built-In Soft Cover 40

Ref BGA0015

Specific to · Especifico para:
L Class 40 Inox / Special

Countertop · Sobre-encimera



Countertop Soft Cover 20

Ref BGA0023

Specific to · Especifico para:
L Class 20 Original / Matte / Inox / Special

Countertop Soft Cover 30

Ref BGA0022

Specific to · Especifico para:
L Class 30 Original / Matte / Inox / Special

Countertop Soft Cover 40

Ref BGA0021

Specific to · Especifico para:
L Class 40 Inox / Special

On-cart · Sobre carro



On-cart Soft Cover 20

Ref BGA0020

Specific to · Especifico para:
L Class 20 Original / Matte / Inox / Special

On-cart Soft Cover 30

Ref BGA0019

Specific to · Especifico para:
L Class 30 Original / Matte / Inox / Special

On-cart Soft Cover 40

Ref BGA0018

Specific to · Especifico para:
L Class 40 Inox / Special

Technical Data

Datos Técnicos



Modula Outdoor Kitchen

KC 80 Grill

Ref BKC0034

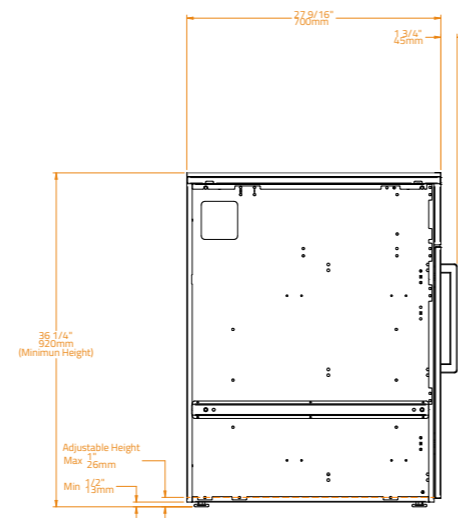
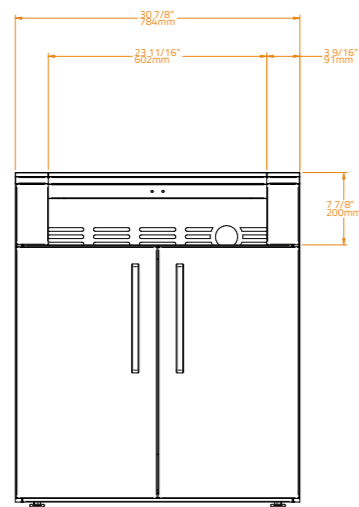

KC 80 Plancha

Ref BKC0007

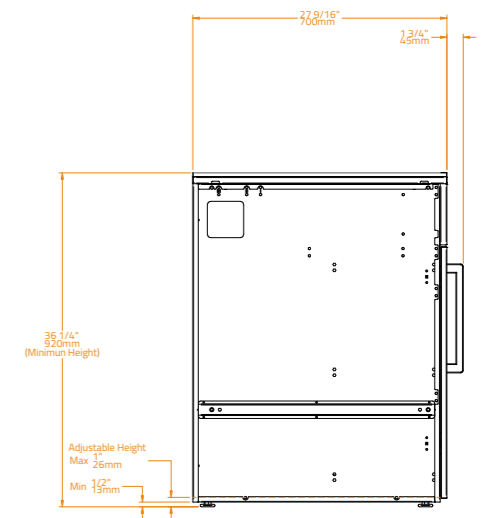
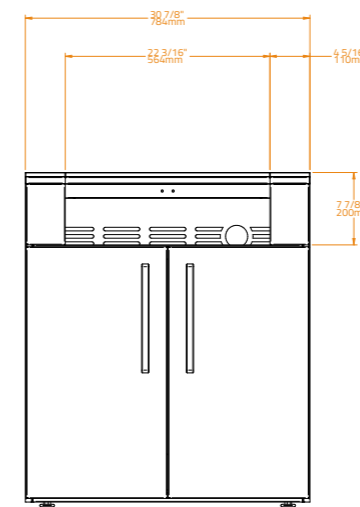

KC 100 Grill

Ref BKC0006

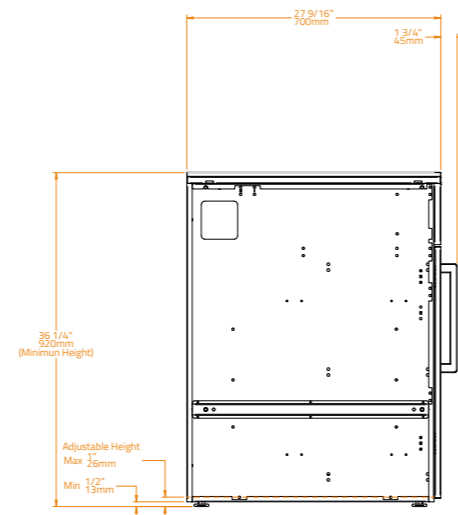
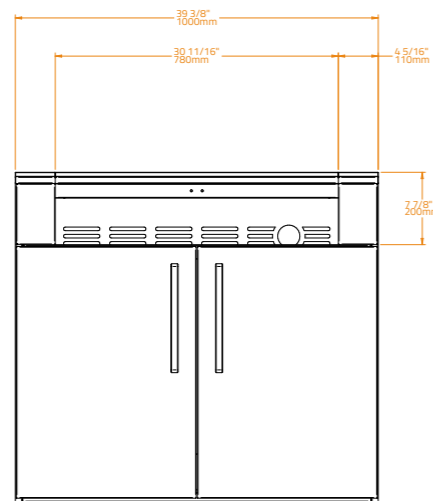

KC 100 Plancha

Ref BKC0023

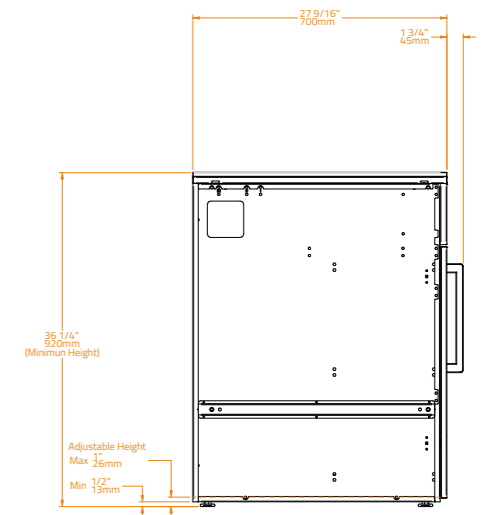
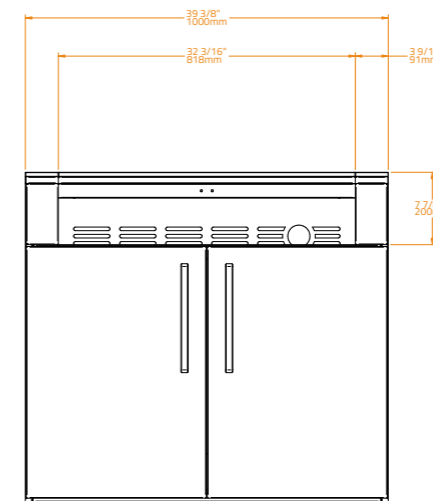

KC 120 Grill

Ref BKC0005

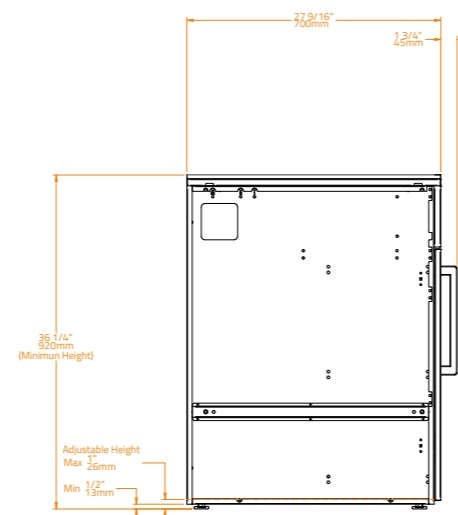
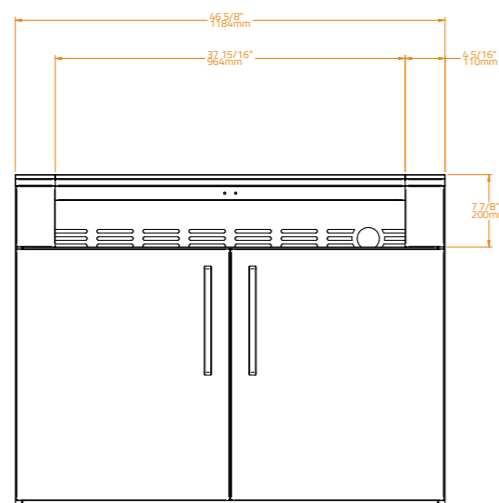

KC 120 Plancha

Ref BKC0024

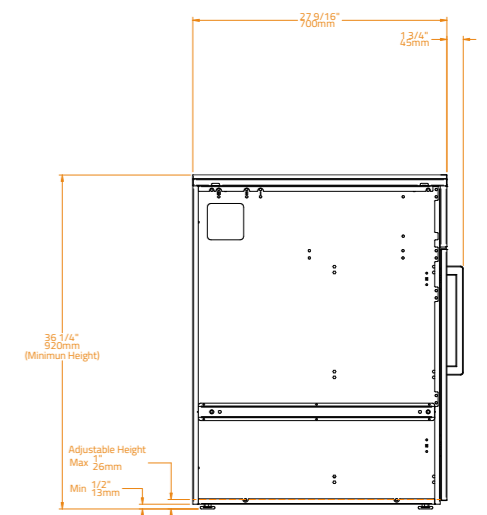
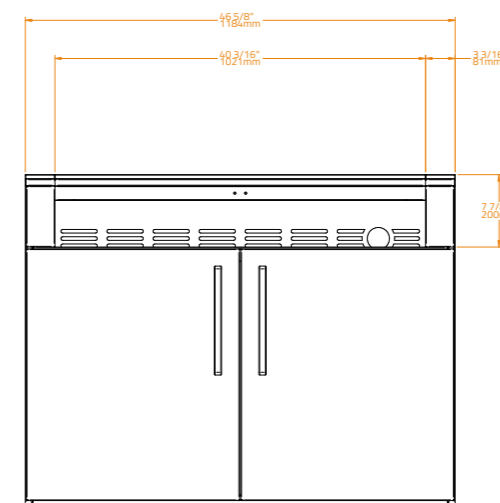

Modula Outdoor Kitchen

KC 120 Drop-In Grill

Ref BKC0028

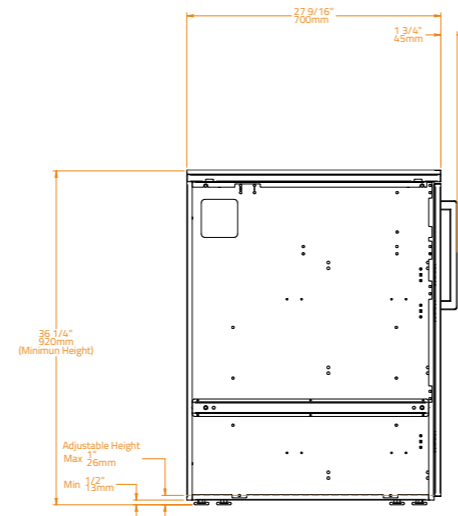
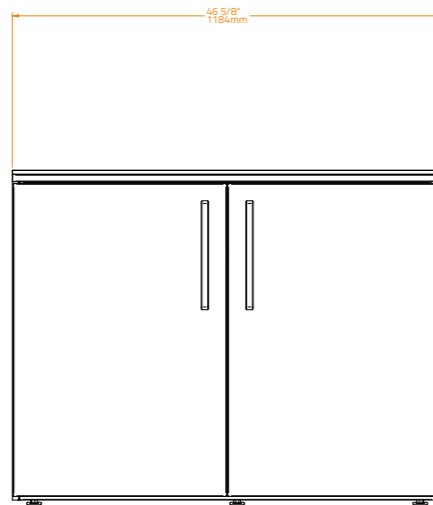

CT 60 Countertop Side Burners

Ref BKC0025

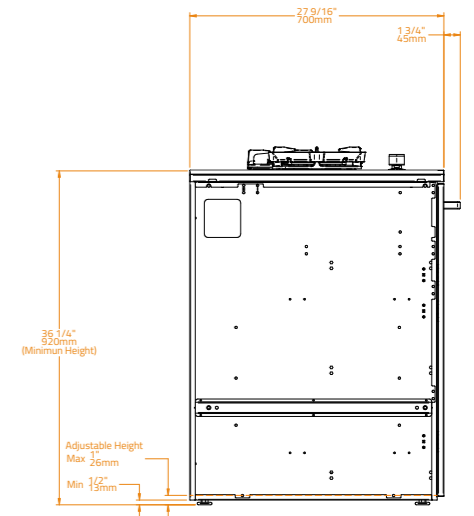
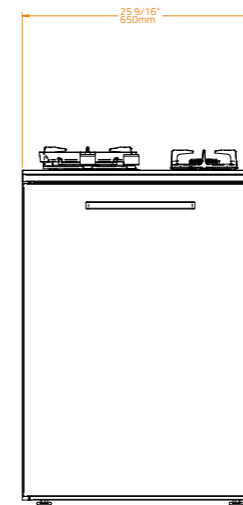
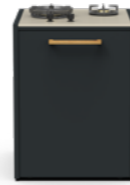

CT 90 Oven

Ref BKC0029

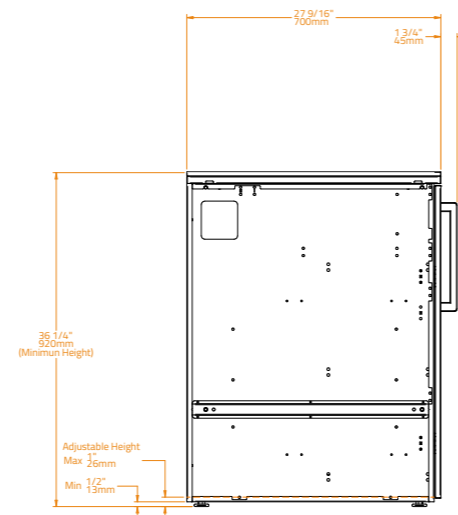
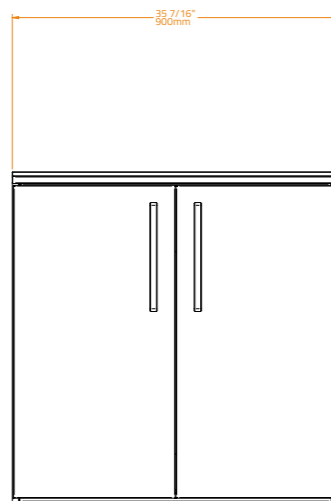

CT 60 Sink

Ref BKC0027

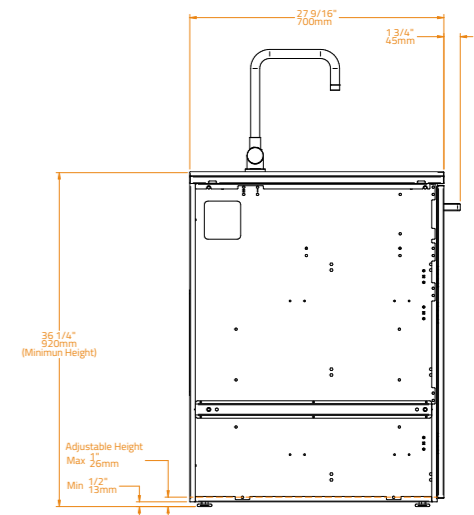
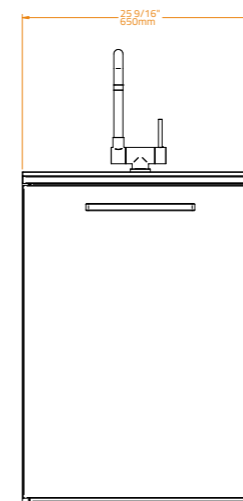

CT 80 Kamado

Ref BKC0020

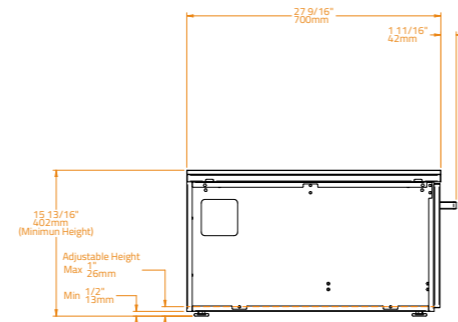
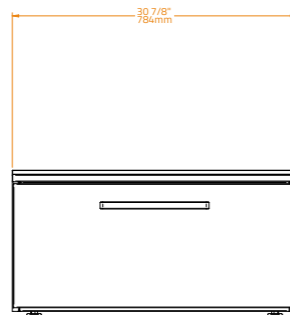

CT 90 Sink

Ref BKC0003

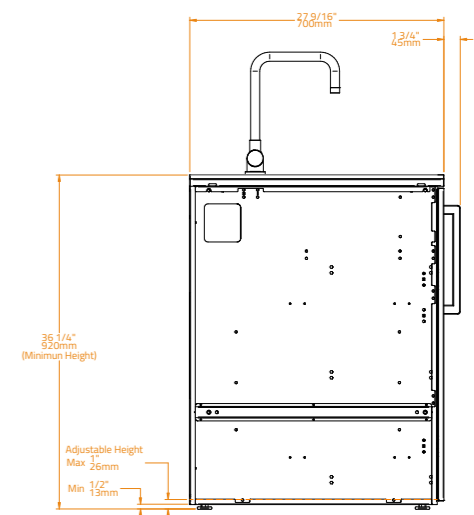
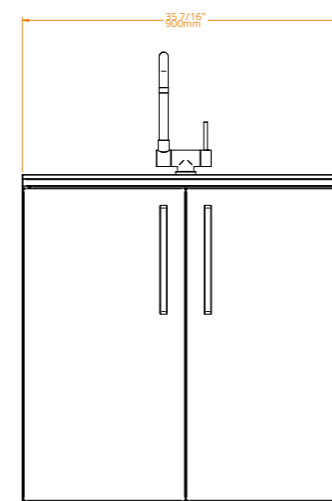

Modula Outdoor Kitchen

CT 60 Fridge

Ref BKC0021

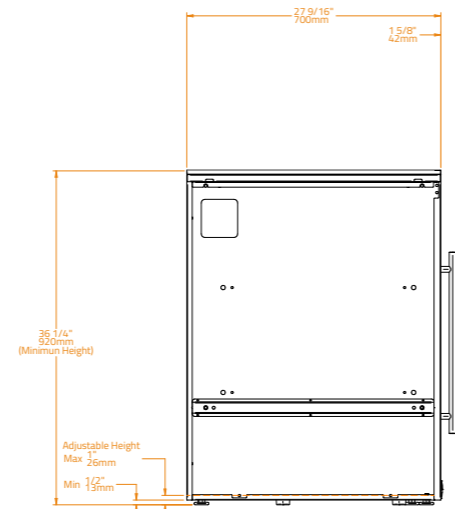
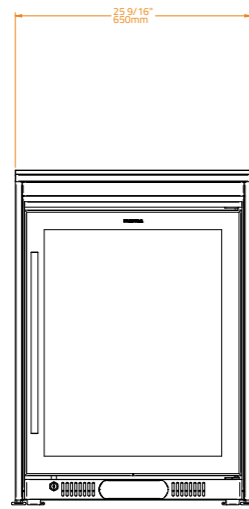

CT 90 Corner

Ref BKC0008

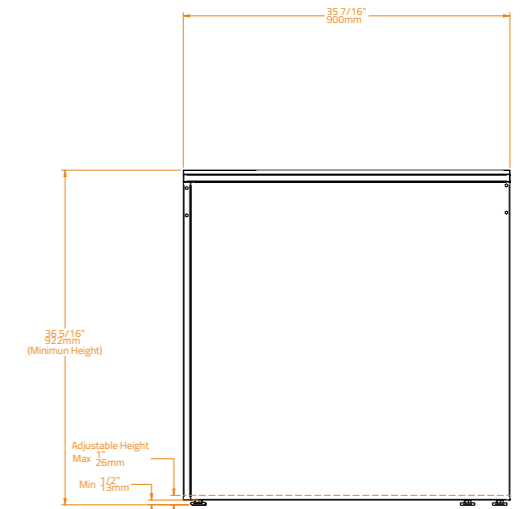
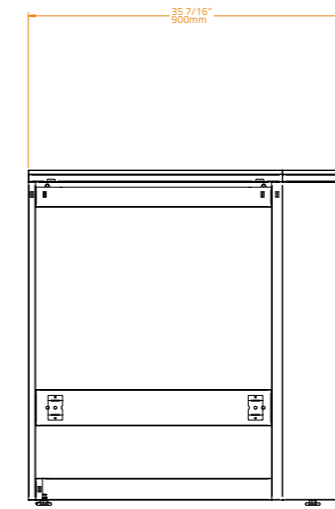
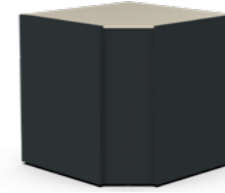

CT 60 Panel Ready Fridge

Ref BKC0035

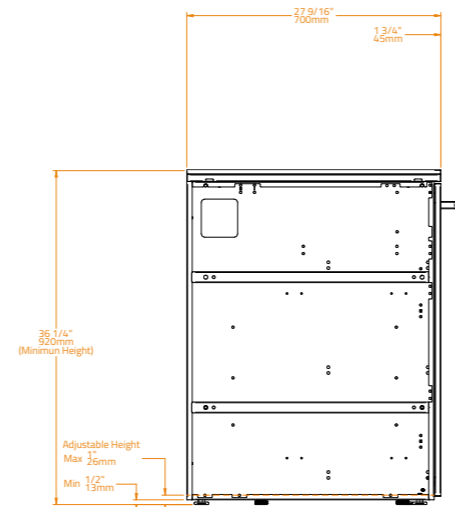
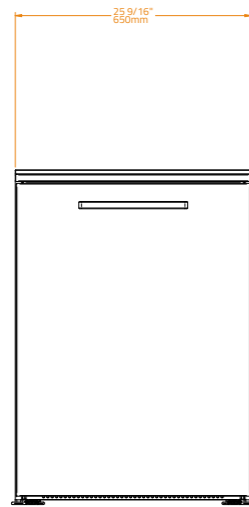

CT 90 Plant Corner

Ref BKC0038

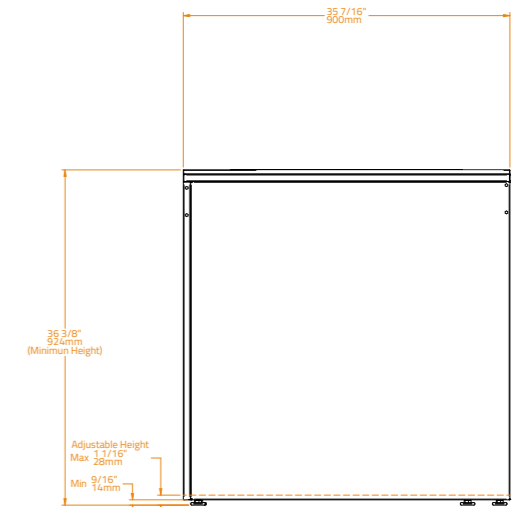
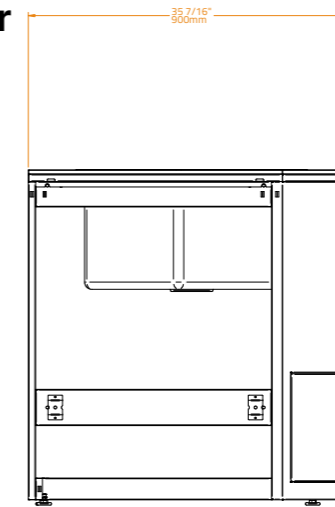

CT 50 Panel Ready Ice Maker

Ref BKC0025

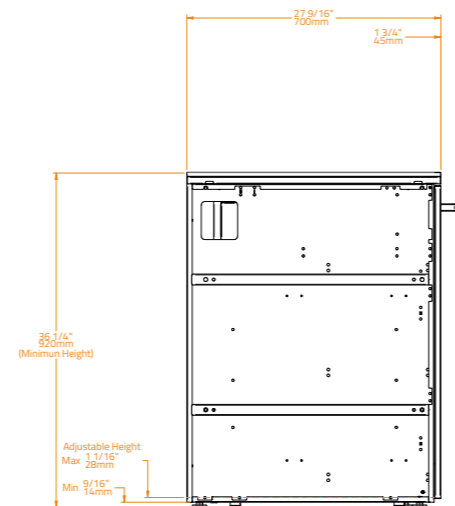

CT 90 Ice Cube Bin Corner

Ref BKC0037

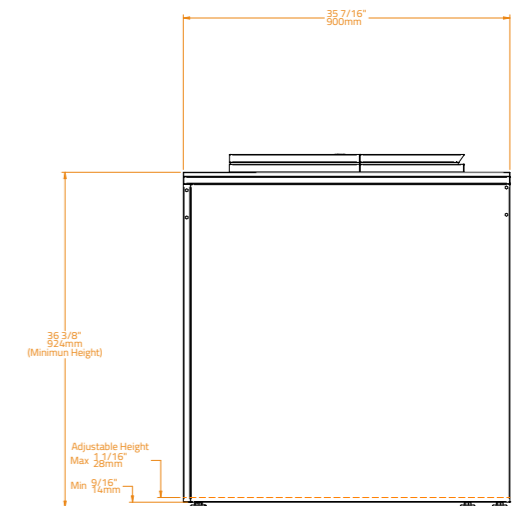
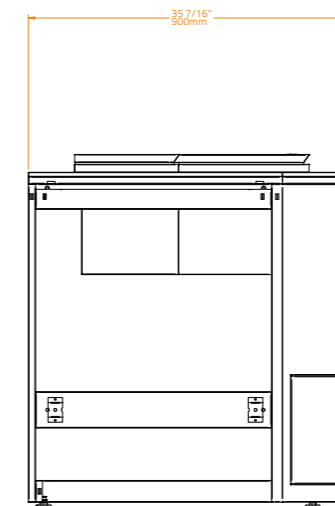

Modula Outdoor Kitchen

CT 60 Ice Cube Bin

Ref BKC0039

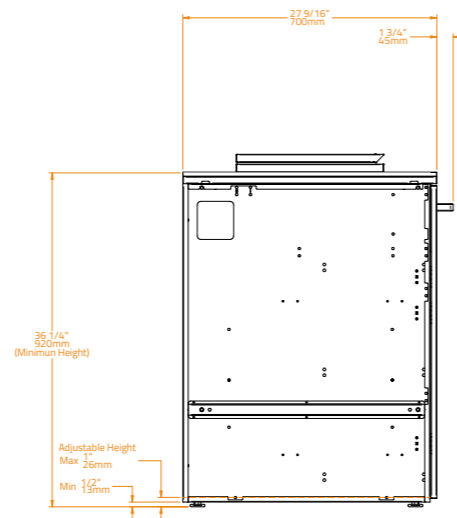
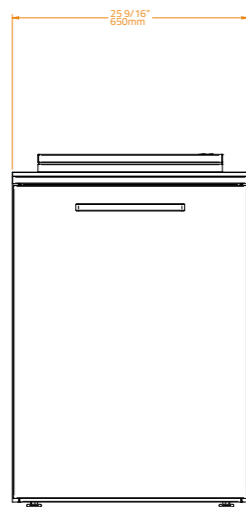

CT 60 Drawers

Ref BKC0026

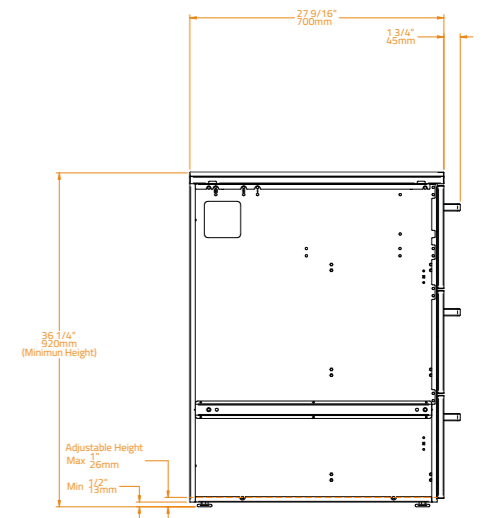
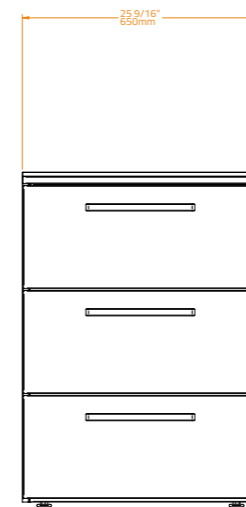
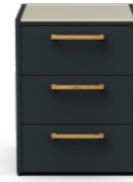

CT 60 Worktop

Ref BKC0035

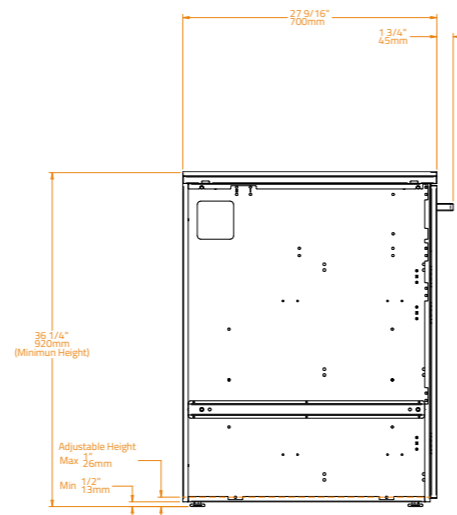
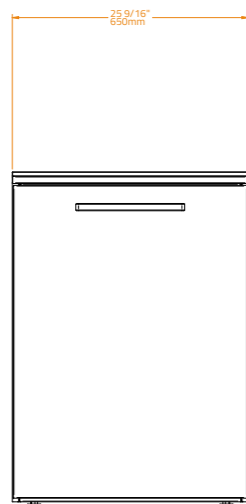

CT 90 Drawers

Ref BKC0001

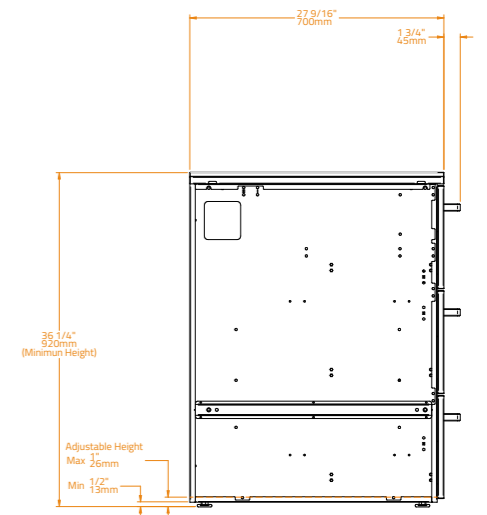
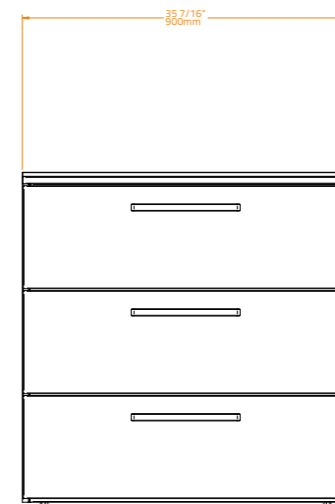

CT 60 Trash Drawers

Ref BKC0002

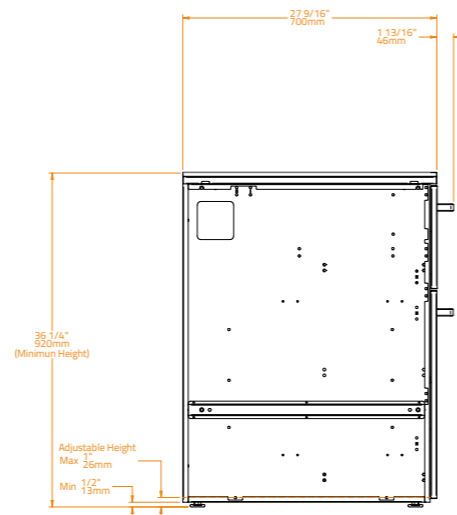
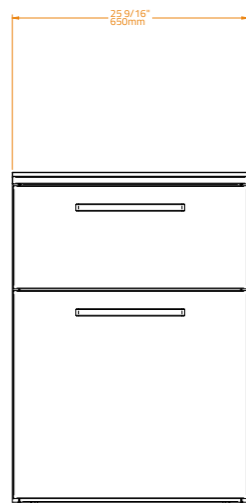

CT 90 Open

Ref BKC0004

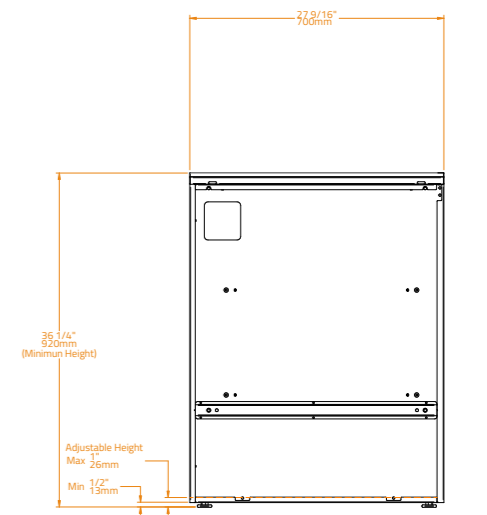
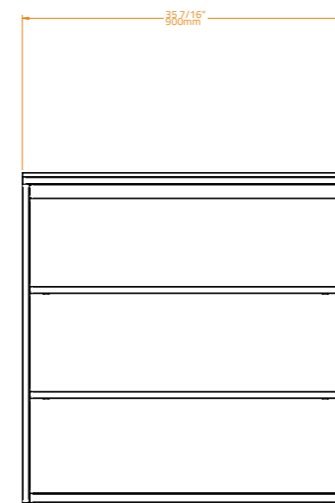

Modula Walls & Standing Bars

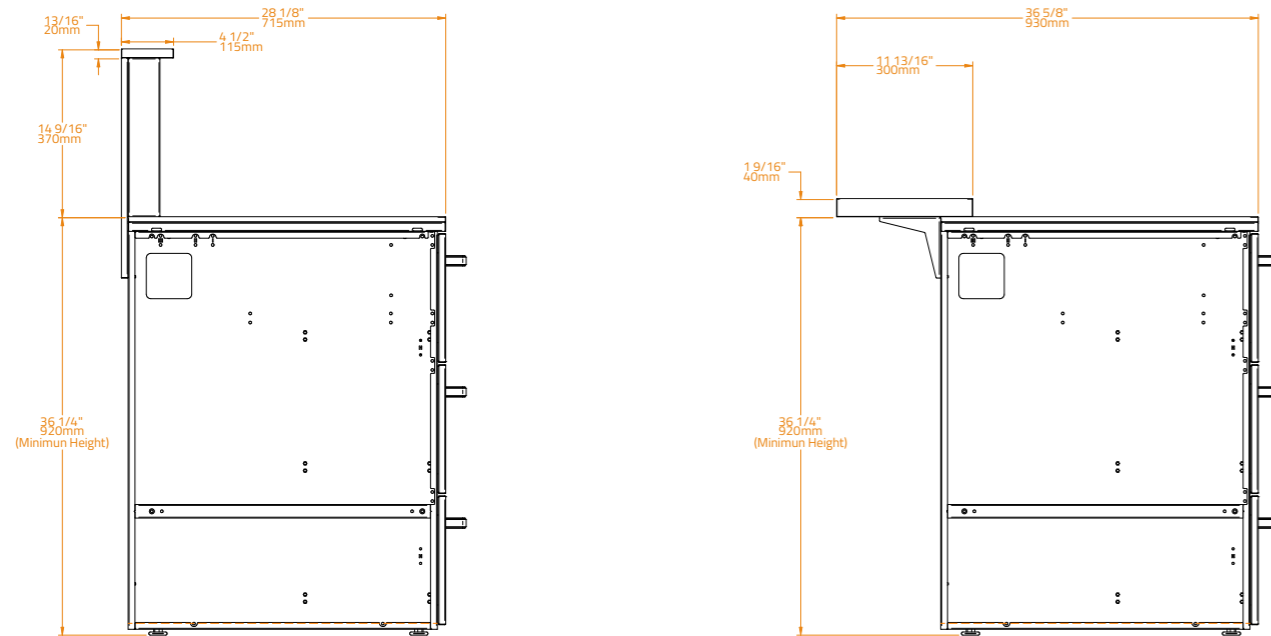

Wall 80

Ref BKC0010

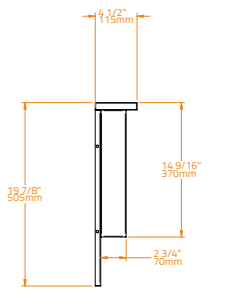
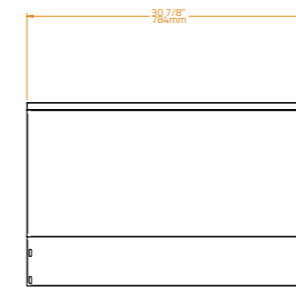

Wall 90

Ref BKC0011

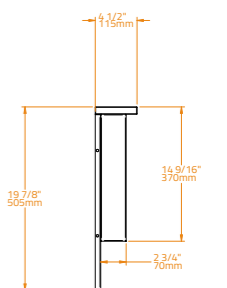
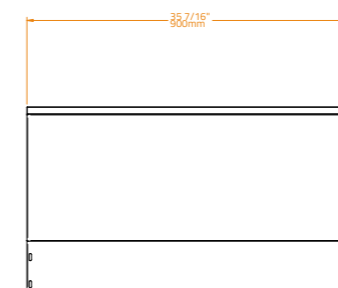

Wall 90 Corner

Ref BKC0031

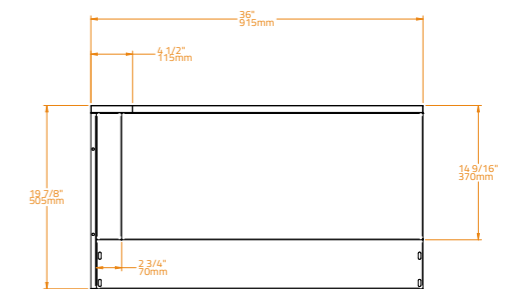
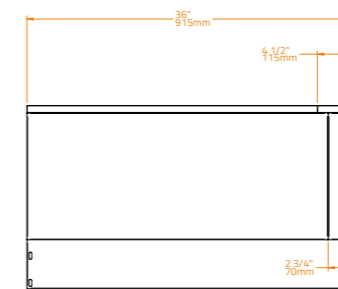
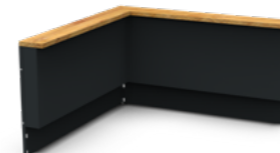

Wall 50

Ref BKC0041

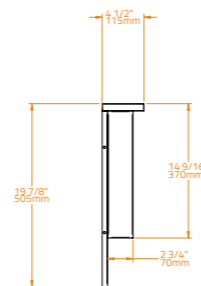
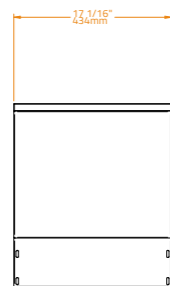

Wall 100

Ref BKC0012

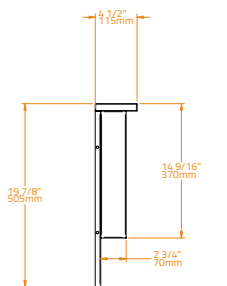
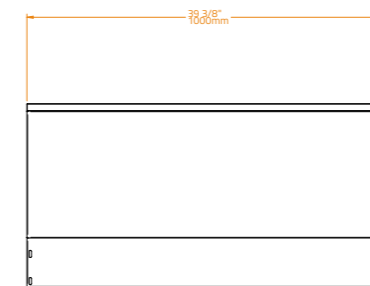

Wall 60

Ref BKC0009

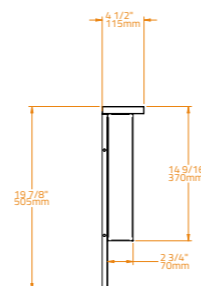
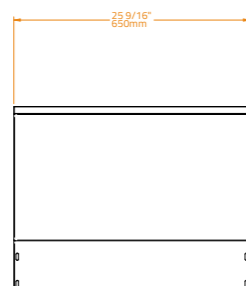

Wall 120

Ref BKC0013

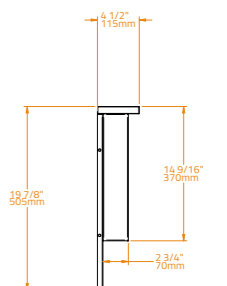
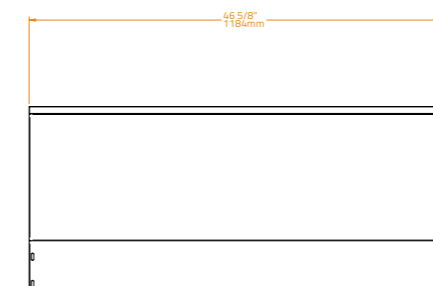

Modula Walls & Standing Bars

Standing Bar 50

Ref BKC0042

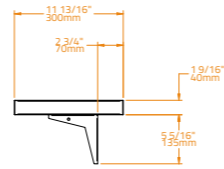
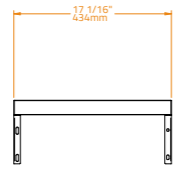

Standing Bar 60

Ref BKC0014

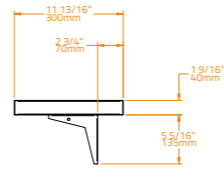
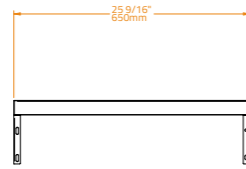

Standing Bar 80

Ref BKC0015

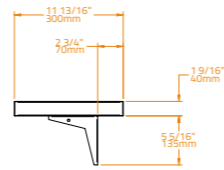
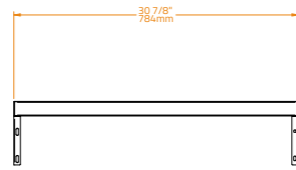

Standing Bar 90

Ref BKC0016

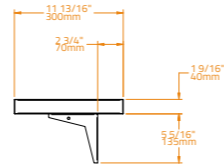
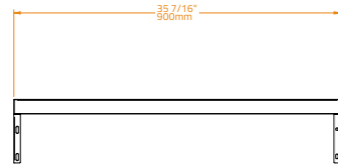

Standing Bar 100

Ref BKC0017

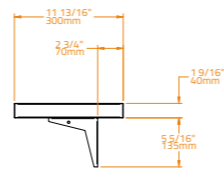
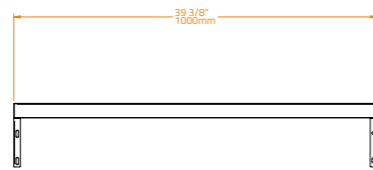

Standing Bar 120

Ref BKC0018

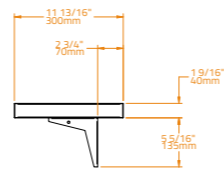
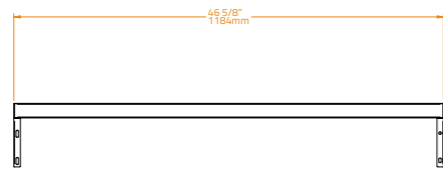

Kitchen LITE Series

LITE Series 300

Ref BKC0033

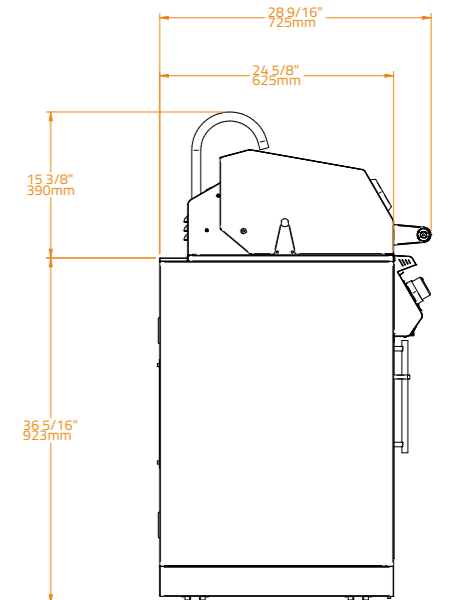
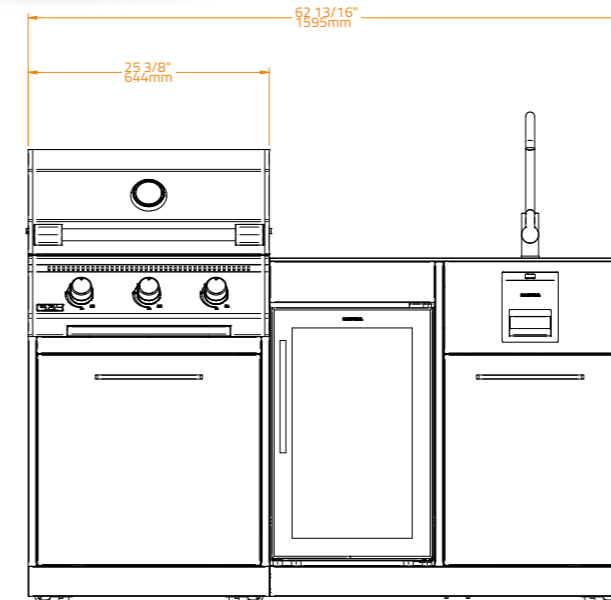

LITE Series 400

Ref BKC0032

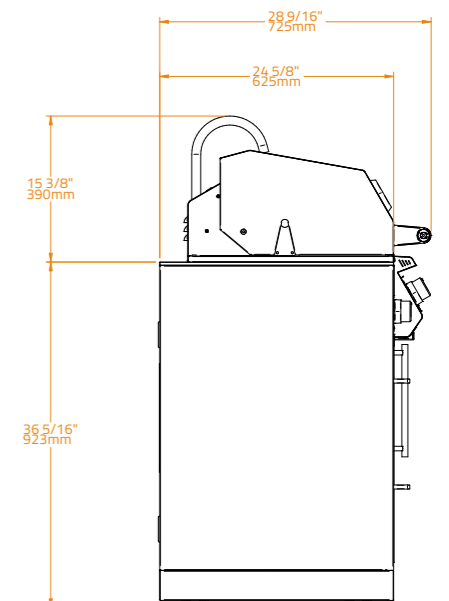
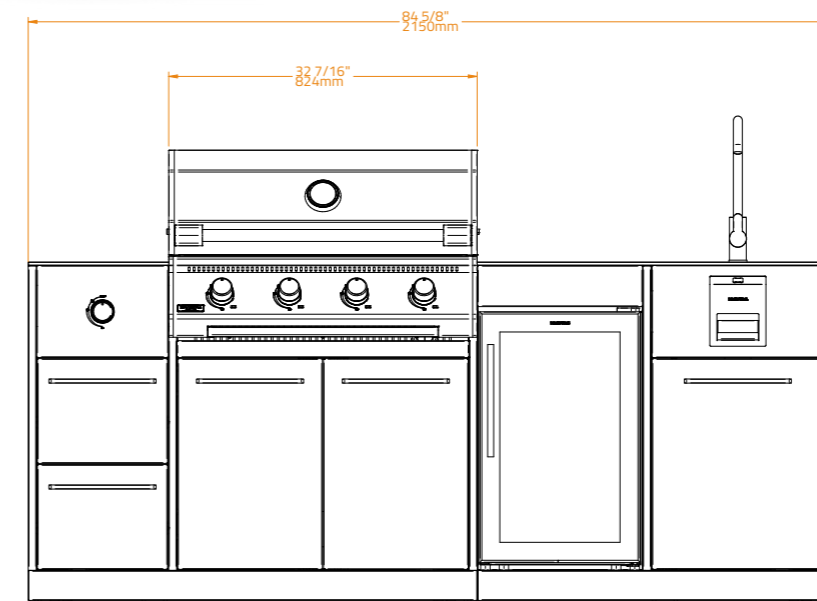

Grills

Box-Q / Box-Q S

Ref BGG0018 / Ref BGG0024

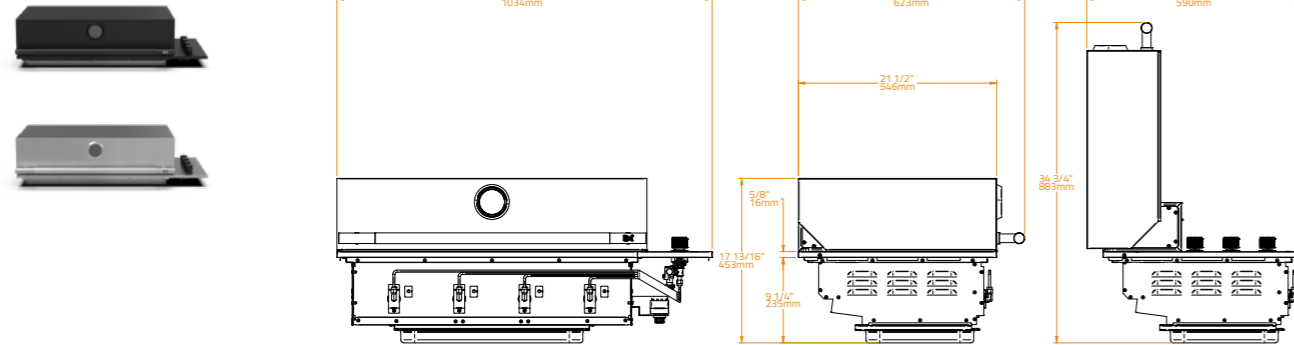

Fusion 300 LITE

Ref BGG0027

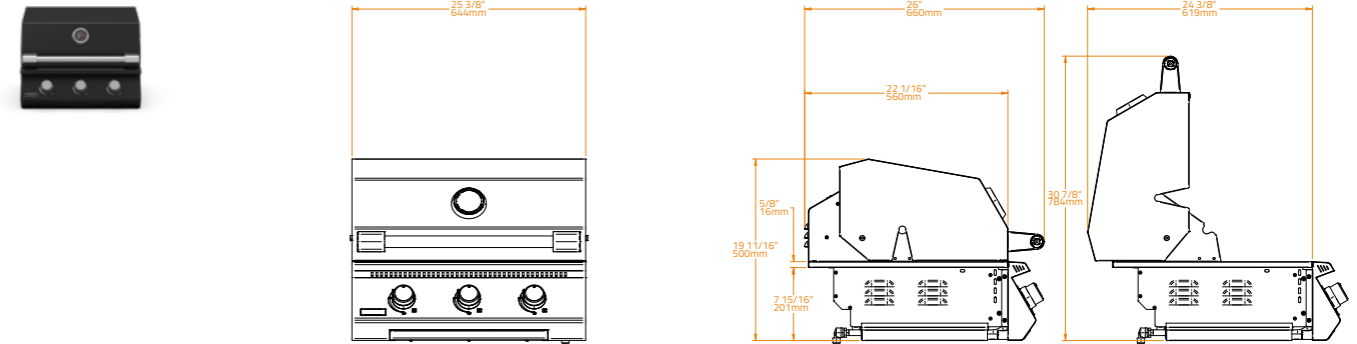

Fusion 400 RS / RM

Ref BGG0013 / Ref BGG0015

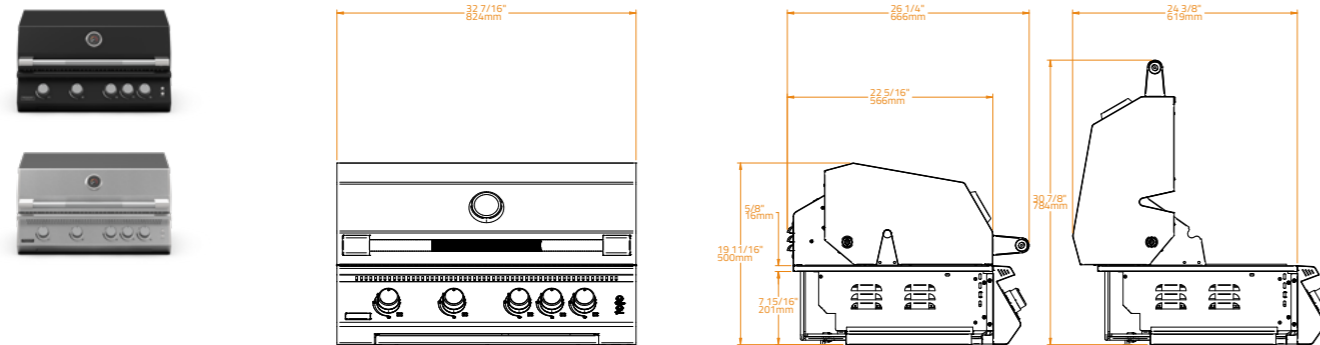

Fusion 400 LITE

Ref BGG0026

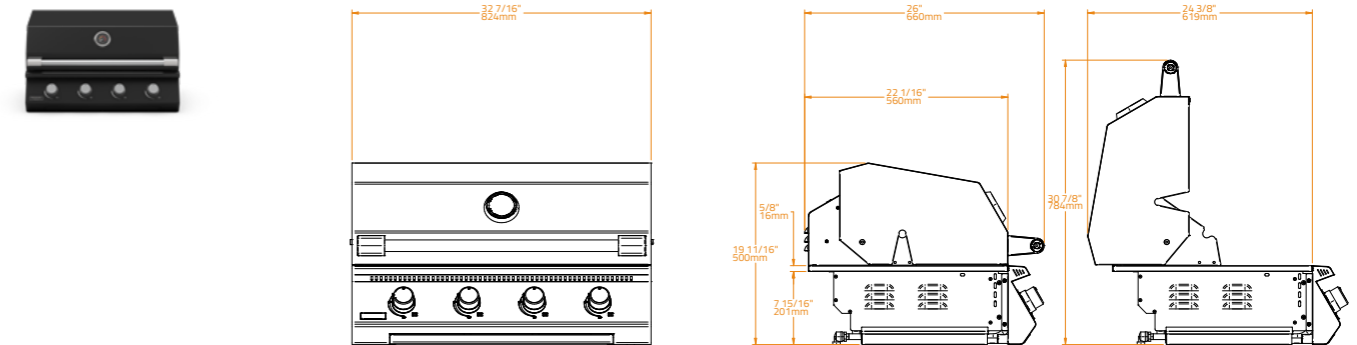

Fusion 500 RS / RM

Ref BGG0014 / Ref BGG0016

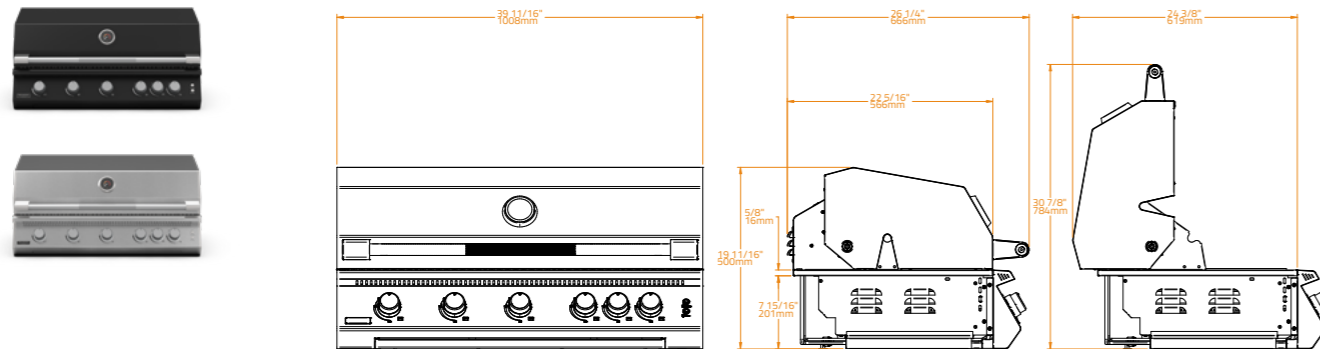

Charcoal Grill Ember 800

Ref BCG0001

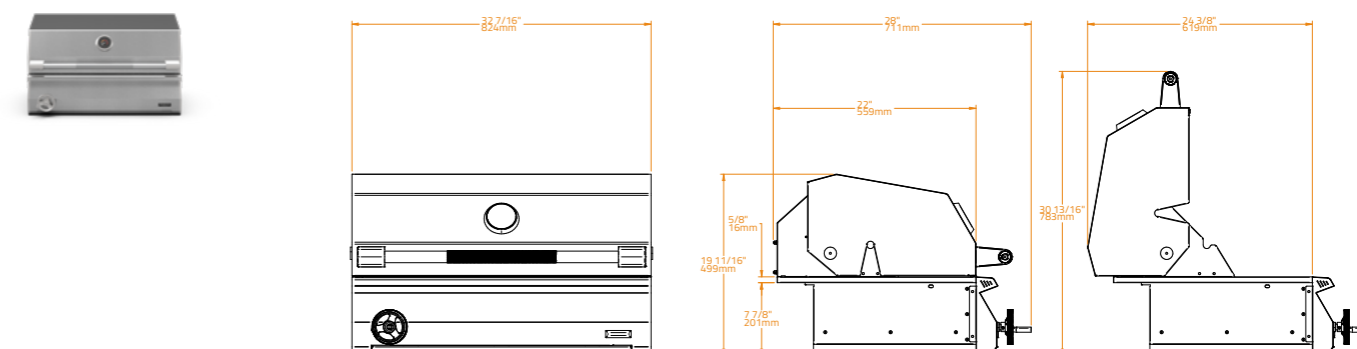

Grill Accessories

Cart Grill 400 S / Cart Grill 400 M

Ref BGC0007 / Ref BGC0009

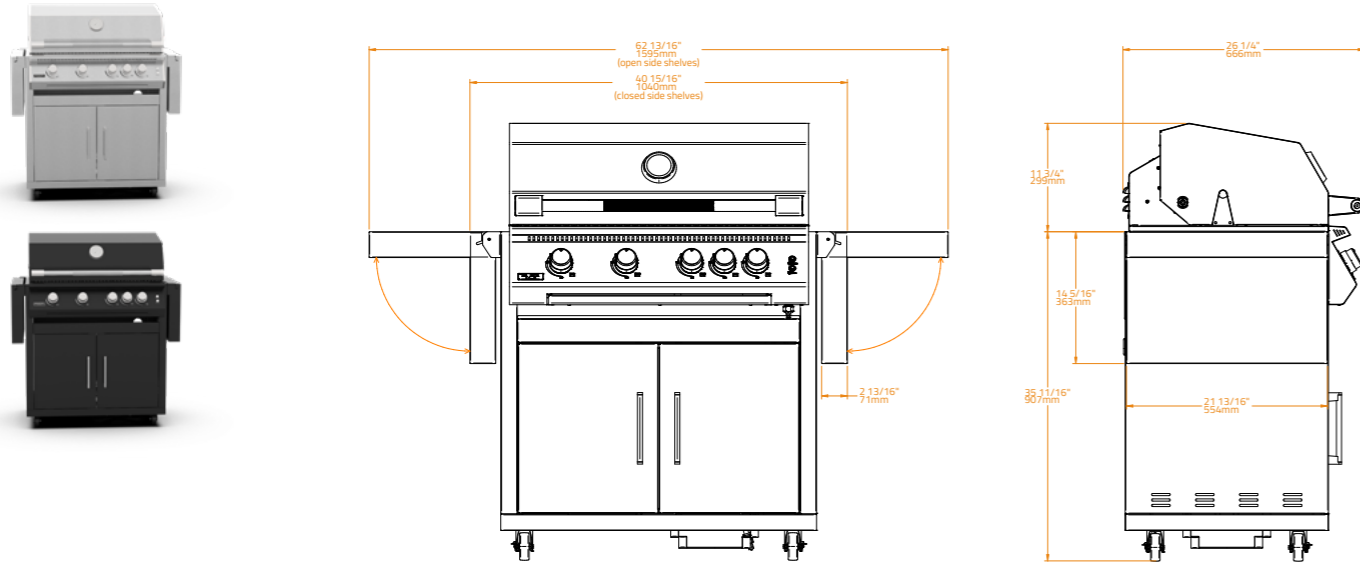

Liner 400 S

Ref BGL0004

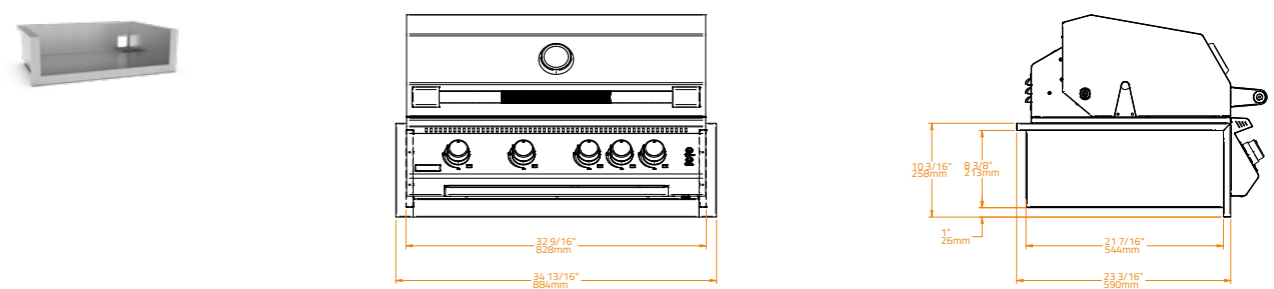

Cart Grill 500 S / Cart Grill 500 M

Ref BGC0008 / Ref BGC0010

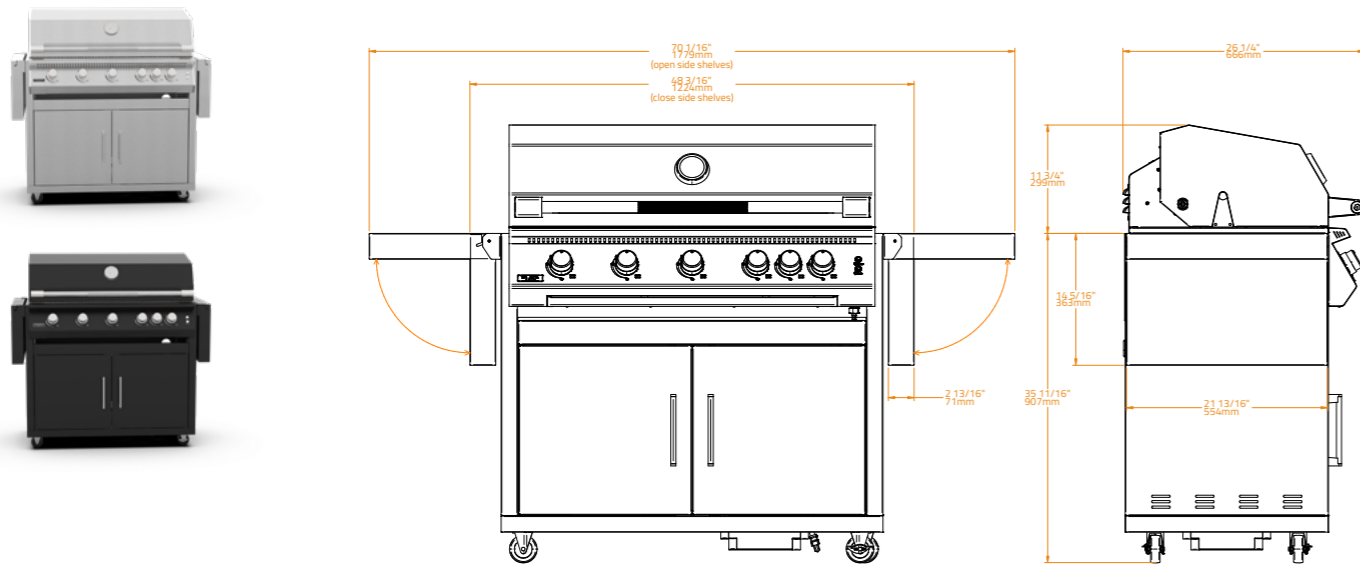

Liner 500 S

Ref BGL0005

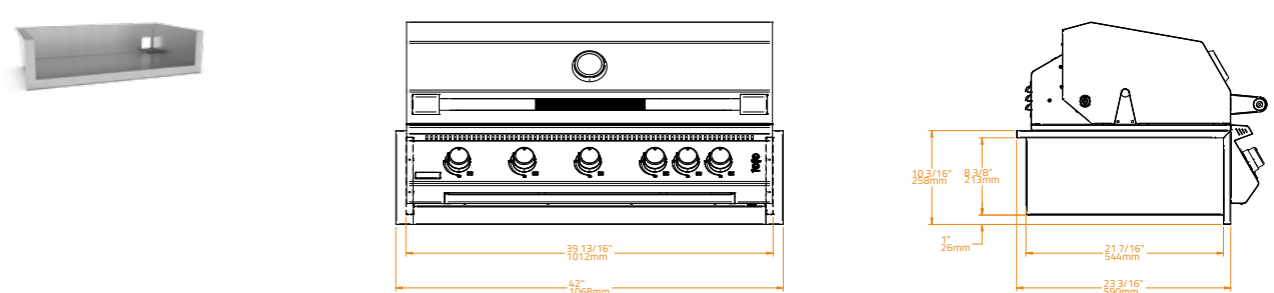

Kalentia & Gelantia

Capitano Pizza Oven 60

Ref BGG0017

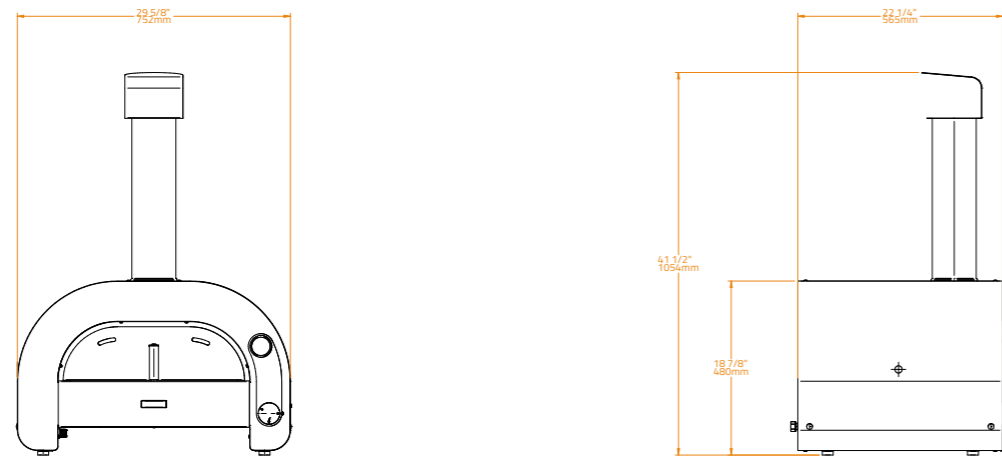

Outdoor Fridge SC-128F

Ref BGSC0024

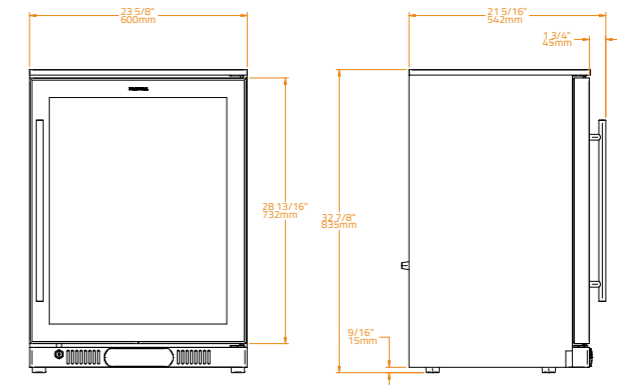

Bison Kamado 23

Ref BCG0002

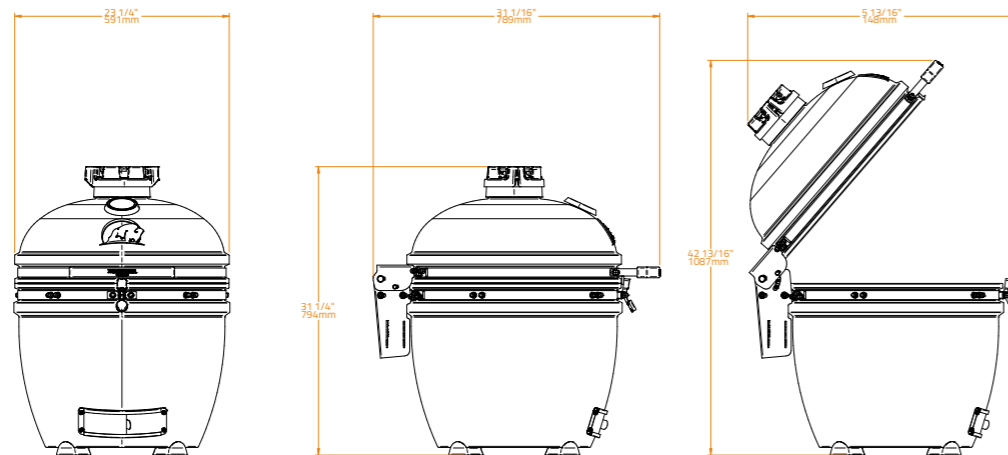

Outdoor Fridge SC-60F

Ref BGSC0151

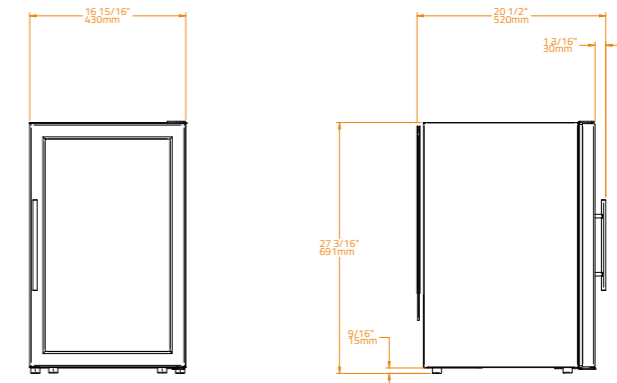

Countertop Side Burners

Ref BGG0019

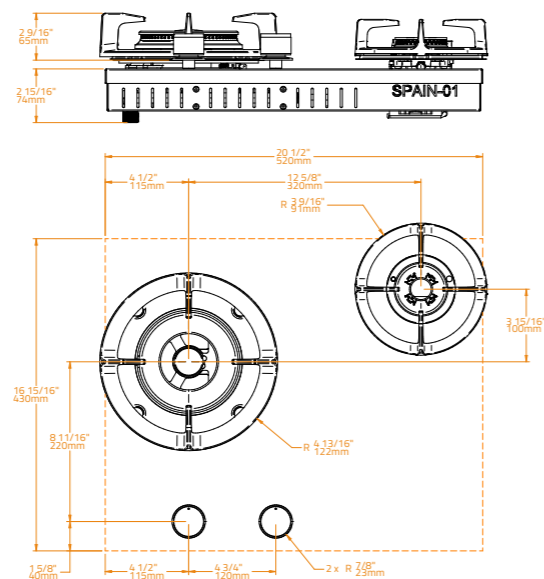

Planchas

L Class Inox 20 / L Class Special 20

Ref BGG0006 / Ref BGG0012

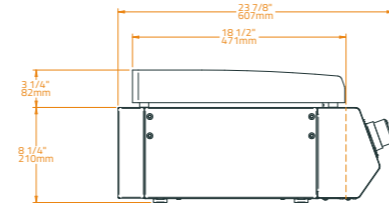
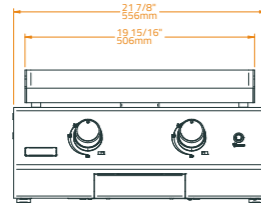

L Class Original 20 / L Class Matte 20

Ref BGG0003 / Ref BGG0009

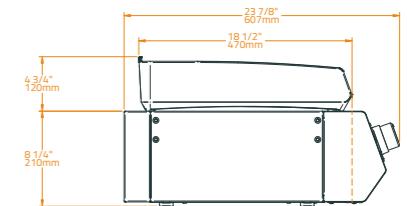
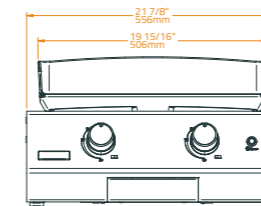

L Class Inox 30 / L Class Special 30

Ref BGG0005 / Ref BGG0011

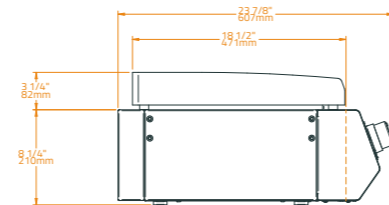
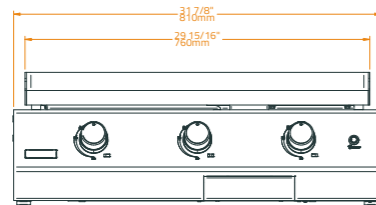

L Class Original 30 / L Class Matte 30

Ref BGG0002 / Ref BGG0008

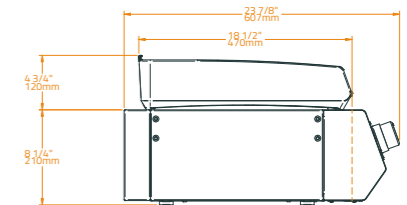
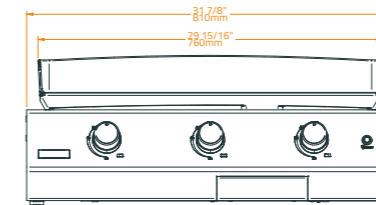

L Class Inox 40 / L Class Special 40

Ref BGG0004 / Ref BGG0010

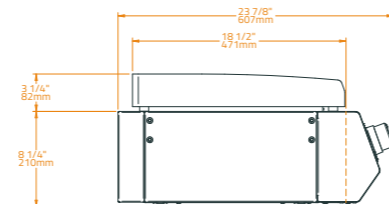
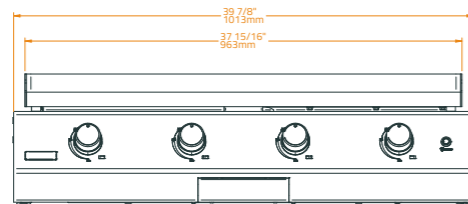

Planchas Accessories

Inox Cart 20/ Matte Cart 20

Ref BGC0003 / Ref BGC0006

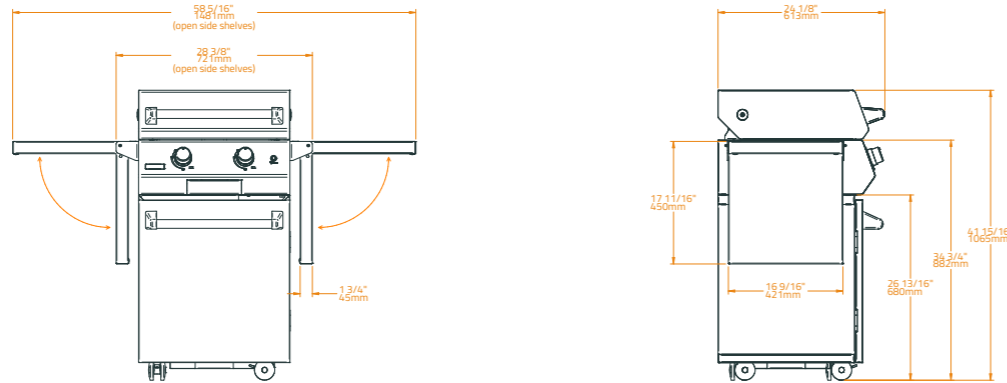

Inox Cover 20/ Matte Cover 20

Ref BGLD0006 / Ref BGLD0007

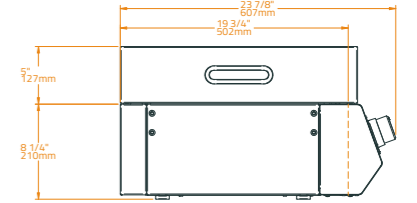
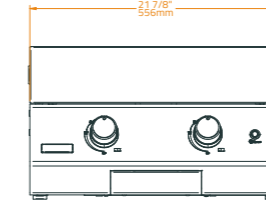

Inox Cart 30/ Matte Cart 30

Ref BGC0002 / Ref BGC0005

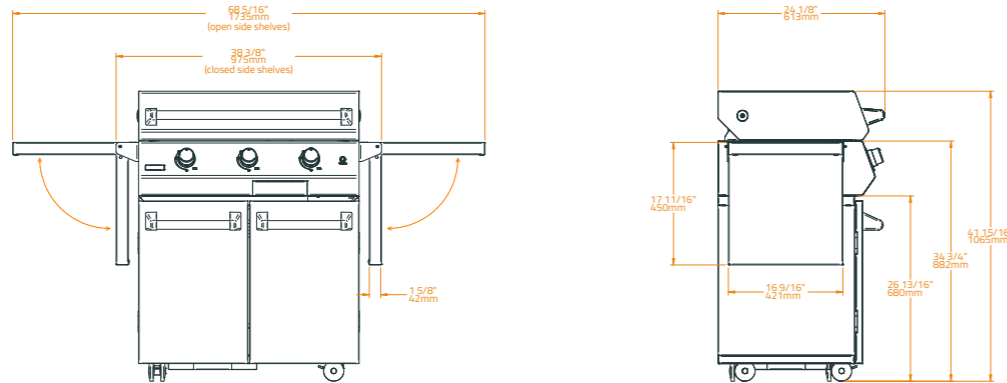

Inox Cover 30 / Matte Cover 30

Ref BGLD0005 / Ref BGLD0008

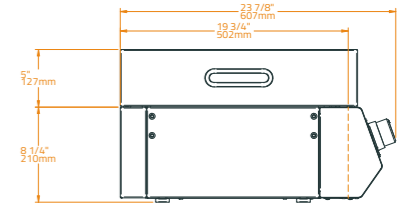
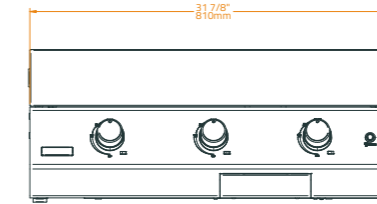

Inox Cart 40 / Matte Cart 40

Ref BGC0001 / Ref BGC0004

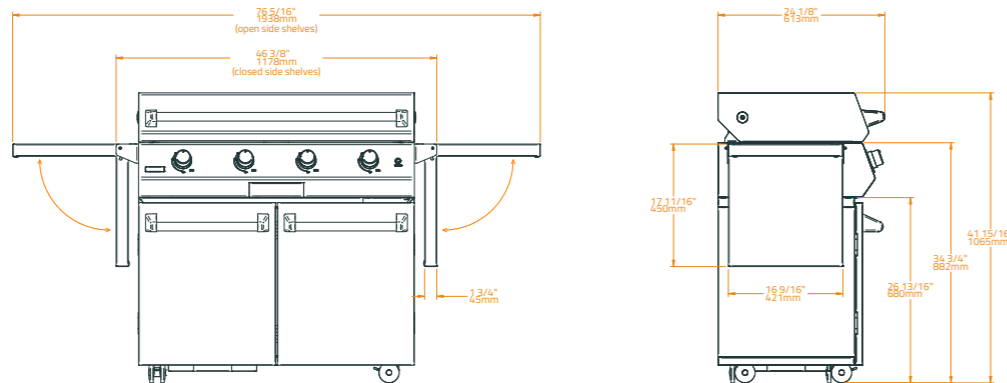

Inox Cover 40 / Matte Cover 40

Ref BGLD0004 / Ref BGLD0009

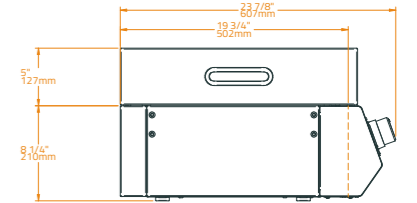
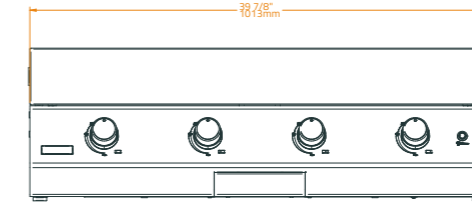
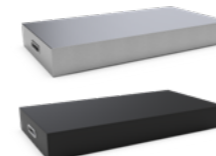

Planchas Accessories

Lid 20

Ref BGLD0003

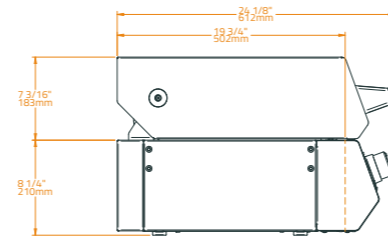
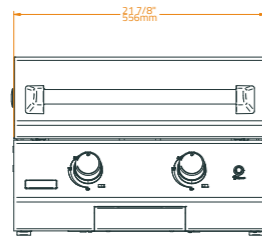

Liner 20

Ref BGL0003

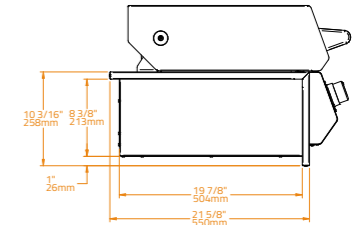
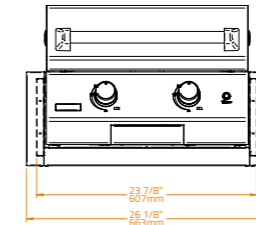

Lid 30

Ref BGLD0002

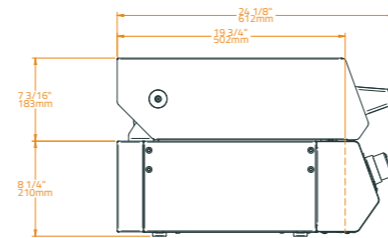
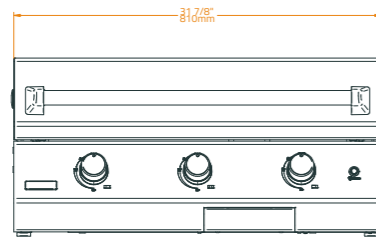
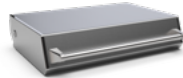

Liner 30

Ref BGL0002

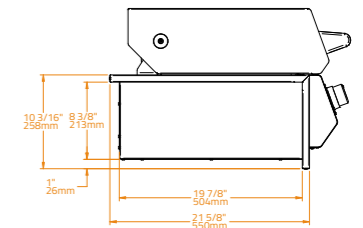
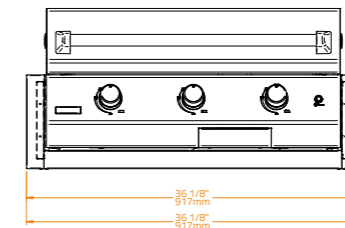

Lid 40

Ref BGLD0001

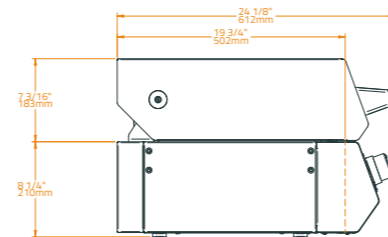
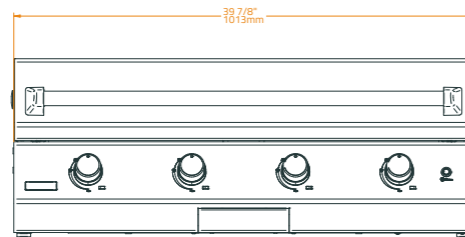
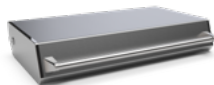

Liner 40

Ref BGL0001

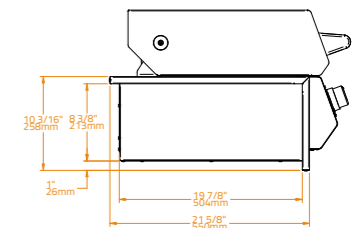
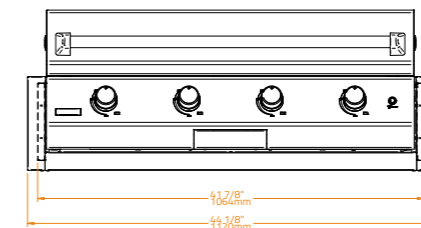

Warranty
Garantía

BRABURA
GRILLS

Brabura Lifetime Warranty
Garantía de por Vida Brabura

Limited Lifetime Warranty

At Brabura, we are committed to the quality and durability of our products.

Grills, Planchas and Countertop Side Burners

That's why we offer a lifetime warranty for certain key components in our barbecues and griddles. This warranty is designed to provide you with the utmost peace of mind and ensure that your culinary experience with Brabura remains exceptional throughout the years you own your product.

Lifetime Warranty:

- ✓ Enameled cast iron and stainless steel cooking plates.
- ✓ Cast stainless steel and U-shaped stainless steel burners.
- ✓ Stainless steel cooking grates with hexagonal rod.
- ✓ Stainless steel chassis.
- ✓ Burners cast iron grates

Five-Year (5) Warranty:

- ✓ Coated stainless steel hoods and control panels on grills and planchas
- ✓ Lids, covers, carts and insulated jackets
- ✓ Gas valves
- ✓ Inner liners
- ✓ Flavor grids
- ✓ Infrared burners in the grill
- ✓ Manifold assemblies

Three-Year (3) Warranty:

- ✓ Ignition systems (excluding batteries)
- ✓ Electrical components
- ✓ Knobs
- ✓ Soft covers and accessories
- ✓ Lift assemblies
- ✓ All other moving parts

Warranty Claim Procedure:

Brabura Grills will repair or replace defective modules at its discretion. Submit written claims with images. For warranty inquiries, contact Tel: +34 667 37 48 74 or E-mail: info@braburagrills.com. Send correspondence to: Brabura Grills SL, Calle Acero, 12 - 06220 - Villafranca de los Barros (Badajoz), España.

Brabura Grills SL is not liable for damages due to misuse, incorrect installation, or improper operation. Brabura product owners who purchased through Brabura dealers can register their warranty at <https://www.braburagrills.com> from within the "Register Your Warranty".

Garantía Limitada de por Vida

En Brabura, estamos comprometidos con la calidad y la durabilidad de nuestros productos.

Parrillas, Planchas y Quemadores Laterales de Encimera

Por ello, ofrecemos una garantía de por vida para una selección de componentes esenciales en nuestras parrillas y placas de cocción. Esta garantía tiene como objetivo brindarle la máxima tranquilidad y asegurar que su experiencia culinaria con Brabura sea excepcional durante todos los años que posea su producto.

Garantía de por Vida

- ✓ Placas de hierro fundido esmaltado y acero inoxidable
- ✓ Quemadores de hierro fundido y quemadores en U de acero inoxidable
- ✓ Parrillas de acero inoxidable con barras hexagonales
- ✓ Chasis de acero inoxidable
- ✓ Parrillas de hierro fundido para quemadores

Garantía de Cinco (5) Años:

- ✓ Tapas y paneles de control galvanizados y pintados para placas de cocción y parrillas
- ✓ Tapas, carros y revestimientos aislantes
- ✓ Válvulas de gas
- ✓ Revestimientos internos
- ✓ Difusores de calor
- ✓ Quemadores infrarrojos en las parrillas
- ✓ Rampas de gas

Garantía de Tres (3) Años:

- ✓ Sistemas de encendido (excepto pilas)
- ✓ Componentes eléctricos
- ✓ Manijas
- ✓ Fundas y accesorios
- ✓ Conjuntos de elevación
- ✓ Otras piezas móviles

Procedimiento para Reclamar la Garantía:

Brabura Grills reparará o reemplazará los módulos defectuosos a su discreción. Por favor, envíe sus reclamaciones por escrito junto con imágenes. Para cualquier consulta relacionada con la garantía, puede comunicarse al teléfono: +34 667 37 48 74 o por correo electrónico: info@braburagrills.com. Envíe su correspondencia a: Brabura Grills SL, Calle Acero, 12, 06220 - Villafranca de los Barros (Badajoz), España.

Brabura Grills SL no se hace responsable de los daños causados por un uso inadecuado, una instalación incorrecta o un funcionamiento indebido. Los propietarios de productos Brabura que hayan realizado su compra a través de los distribuidores autorizados de Brabura pueden registrar su garantía en <https://www.braburagrills.com> desde la sección "Registre su garantía".



Limited Lifetime Warranty

At Brabura, we are committed to the quality and durability of our products.

Kitchen Modula

Brabura Outdoor Kitchens Modula, where craftsmanship meets longevity. This residential-exclusive, non-transferable warranty covers defects in materials and workmanship, excluding normal wear and tear, misuse, abuse, or improper installation.

Limited Warranties:

- ✓ Drawer guides and hinges: three (3) years, spare parts available.
- ✓ Painted finishes: three (3) years, weather-resistant.
- ✓ Overall structural integrity: ten (10) years (excluding handles).
- ✓ Refrigerator: three (3) years, additional warranty for specific components.
- ✓ Neolith countertops: twenty-five (25) years warranty for residential use.
- ✓ Bamboo kitchen parts: Treated with marine varnish, superficial wear not covered. Regular care needed, especially in harsh conditions.

Warranty Conditions and Limitations:

Covers defects in materials and workmanship, excluding wear and tear, aging, and corrosion in coastal installations. Excludes aesthetic damages post-purchase and losses of product contents.

Warranty Claim Procedure:

To ensure you make the most of this warranty, we recommend carefully reading the specific terms and conditions, keeping your purchase documentation, and following our maintenance recommendations. At Brabura, your long-term satisfaction is our top priority, and we are here to provide you with high-quality products that endure over time.

Brabura Grills will repair or replace defective modules at its discretion. Submit written claims with images. For warranty inquiries, contact Tel: +34 667 37 48 74 or E-mail: info@braburagrills.com. Send correspondence to: Brabura Grills SL, Calle Acero, 12 - 06220 - Villafranca de los Barros (Badajoz), España.

Brabura Grills SL is not liable for damages due to misuse, incorrect installation, or improper operation. Brabura product owners who purchased through Brabura dealers can register their warranty at <https://www.braburagrills.com> from within the "Register Your Warranty".

Garantía Limitada de por Vida

En Brabura, estamos comprometidos con la calidad y la durabilidad de nuestros productos.

Kitchen Modula

Brabura Outdoor Kitchens Modula, donde la artesanía se encuentra con la durabilidad. Esta garantía exclusiva para uso residencial y no transferible cubre defectos en materiales y mano de obra, excluyendo el desgaste normal, el uso indebido, el abuso o una instalación incorrecta.

Garantías Limitadas:

- ✓ Guías y bisagras de cajones: Tres (3) años, con disponibilidad de piezas de repuesto.
- ✓ Acabados pintados: Tres (3) años, resistentes a las inclemencias del tiempo.
- ✓ Integridad estructural general: Diez (10) años (excluyendo las manijas).
- ✓ Refrigerador: Tres (3) años, con garantía adicional para componentes específicos.
- ✓ Encimeras de Neolith: Garantía de veinticinco (25) años para uso residencial.
- ✓ Piezas de cocina en bambú: Tratadas con barniz marino, el desgaste superficial no está cubierto. Se requiere un mantenimiento regular, especialmente en condiciones adversas.

Condiciones y Limitaciones de la Garantía:

Cubre defectos de materiales y fabricación, excluyendo los daños causados por golpes, caídas o transporte violento. Excluye daños estéticos posteriores a la compra y pérdidas del contenido del producto.

Procedimiento para Reclamar la Garantía:

Para asegurarse de aprovechar al máximo esta garantía, le recomendamos leer detenidamente los términos y condiciones específicos, conservar la documentación de compra y seguir nuestras recomendaciones de mantenimiento. En Brabura, su satisfacción a largo plazo es nuestra principal prioridad, y estamos aquí para ofrecerle productos de alta calidad que perduren en el tiempo.

Brabura Grills reparará o reemplazará los módulos defectuosos a su discreción. Por favor, envíe sus reclamaciones por escrito junto con imágenes. Para cualquier consulta relacionada con la garantía, puede comunicarse al teléfono: +34 667 37 48 74 o por correo electrónico a: info@braburagrills.com. Envíe su correspondencia a: Brabura Grills SL, Calle Acero, 12 - 06220 - Villafranca de los Barros (Badajoz), España.

Brabura Grills SL no se hace responsable de los daños causados por un uso inadecuado, una instalación incorrecta o un funcionamiento indebido. Los propietarios de productos Brabura que hayan realizado su compra a través de los distribuidores autorizados de Brabura pueden registrar su garantía en <https://www.braburagrills.com> desde la sección "Registre su garantía".



Limited Lifetime Warranty

At Brabura, we are committed to the quality and durability of our products.

Ovens and Kamados

This warranty is designed to provide you with the utmost peace of mind and ensure that your culinary experience with Brabura remains exceptional throughout the years you own your product.

Limited Warranties:

- ✓ Oven: three (3) years, except for refractory stones.
- ✓ Kamado ceramic body and ceramic fire box: twenty (20) years.
- ✓ Kamado stainless steel grates: three (3) years.
- ✓ Other kamado metal parts and pizza stones: three (3) years.
- ✓ Bamboo parts: Treated with marine varnish, superficial wear not covered. Regular care needed, especially in harsh conditions.

Warranty Conditions and Limitations:

Covers defects in materials and workmanship, excluding hit, fall or violent transportation.. Excludes aesthetic damages post-purchase and losses of product contents.

Warranty Claim Procedure:

To ensure you make the most of this warranty, we recommend carefully reading the specific terms and conditions, keeping your purchase documentation, and following our maintenance recommendations. At Brabura, your long-term satisfaction is our top priority, and we are here to provide you with high-quality products that endure over time.

Brabura Grills will repair or replace defective modules at its discretion. Submit written claims with images. For warranty inquiries, contact Tel: +34 667 37 48 74 or E-mail: info@braburagrills.com . Send correspondence to: Brabura Grills SL, Calle Acero, 12 - 06220 – Villafranca de los Barros (Badajoz), España.

Brabura Grills SL is not liable for damages due to misuse, incorrect installation, or improper operation. Brabura product owners who purchased through Brabura dealers can register their warranty at <https://www.braburagrills.com> from within the "Register Your Warranty".

Garantía Limitada de por Vida

En Brabura, estamos comprometidos con la calidad y la durabilidad de nuestros productos.

Hornos y Kamados

Esta garantía está diseñada para ofrecerle la máxima tranquilidad y garantizar que su experiencia culinaria con Brabura siga siendo excepcional a lo largo de los años de uso de su producto.

Garantías Limitadas:

- ✓ Horno: Tres (3) años, excluyendo las piedras refractarias.
- ✓ Cuerpo cerámico del Kamado y cámara de combustión cerámica: Veinte (20) años.
- ✓ Rejillas de acero inoxidable del Kamado: Tres (3) años.
- ✓ Otras piezas metálicas del Kamado y piedras para pizza: Tres (3) años.
- ✓ Piezas de bambú: Tratadas con barniz marino, el desgaste superficial no está cubierto. Se requiere mantenimiento regular, especialmente en condiciones difíciles.

Condiciones y Limitaciones de la Garantía:

Cubre defectos de materiales y fabricación, excluyendo los daños causados por golpes, caídas o transporte violento. Excluye daños estéticos posteriores a la compra y pérdidas del contenido del producto.

Procedimiento para Reclamar la Garantía:

Para asegurarse de aprovechar al máximo esta garantía, le recomendamos leer detenidamente los términos y condiciones específicos, conservar la documentación de compra y seguir nuestras recomendaciones de mantenimiento. En Brabura, su satisfacción a largo plazo es nuestra principal prioridad, y estamos aquí para ofrecerle productos de alta calidad que perduren en el tiempo.

Brabura Grills reparará o reemplazará los módulos defectuosos a su discreción. Por favor, envíe sus reclamaciones por escrito junto con imágenes. Para cualquier consulta relacionada con la garantía, puede comunicarse al teléfono: +34 667 37 48 74 o por correo electrónico a: info@braburagrills.com. Envíe su correspondencia a: Brabura Grills SL, Calle Acero, 12 - 06220 – Villafranca de los Barros (Badajoz), España.

Brabura Grills SL no se hace responsable de los daños causados por un uso inadecuado, una instalación incorrecta o un funcionamiento indebido. Los propietarios de productos Brabura que hayan realizado su compra a través de los distribuidores autorizados de Brabura pueden registrar su garantía en <https://www.braburagrills.com> desde la sección "Registre su garantía".







Scan me to set up your kitchen
Escanéame para configurar vuestra cocina

braburagrills.com

BRABURA
OUTDOOR KITCHENS

braburagrills.com

Calle Acero 12 | 06220 | Villafranca de los Barros | Badajoz | Spain
+34 924 091 954 | +34 667 374 874 | info@braburagrills.com